

# SERVICE MANUAL

# FE-2 CHASSIS

<b>MODEL</b>	<b>COMMANDER</b>	<b>DEST</b>	<b>CHASSIS NO.</b>	<b>MODEL</b>	<b>COMMANDER</b>	<b>DEST</b>	<b>CHASSIS NO.</b>
<b>KV-14LT1B</b>	RM-887	French	SCC-Q54B-A	<b>KV-14LM1B</b>	RM-889	French	SCC-Q54D-A
<b>KV-14LT1E</b>	RM-887	Spanish	SCC-Q53B-A	<b>KV-14LM1E</b>	RM-889	Spanish	SCC-Q53D-A
<b>KV-14LT1K</b>	RM-887	OIRT	SCC-Q51B-A	<b>KV-14LM1K</b>	RM-889	OIRT	SCC-Q51D-A
<b>KV-14LT1U</b>	RM-887	UK	SCC-Q52B-A	<b>KV-14LM1U</b>	RM-889	UK	SCC-Q52D-A

## FD Trinitron



TRINITRON<sup>®</sup> COLOR TV  
**SONY<sup>®</sup>**

# TABLE OF CONTENTS

<i>Section</i>	<i>Title</i>	<i>Page</i>	<i>Section</i>	<i>Title</i>	<i>Page</i>
	Specifications .....	3	<b>3. SET-UP ADJUSTMENTS</b>		
	Connectors .....	5	3-1.	Beam Landing .....	14
	Self Diagnostic Software .....	6	3-2.	Convergence .....	15
<b>1. GENERAL</b>			3-3.	Focus Adjustment .....	17
	Switching On the TV and		3-4.	Screen (G2), White Balance .....	17
	Automatically Tuning .....	7	<b>4. CIRCUIT ADJUSTMENTS</b>		
	Introducing the Menu System .....	8	4-1.	Electrical Adjustments .....	18
	Teletext .....	10	4-2.	Test Mode 2 .....	20
	Connecting Optional Equipment.....	10	<b>5. DIAGRAMS</b>		
	Using Optional Equipment .....	10	5-1.	Circuit Board Location .....	22
	Specifications .....	11	5-2.	Block Diagrams .....	23
	Troubleshooting .....	11	5-3.	Schematic Diagrams and	
<b>2. DISASSEMBLY</b>				Printed Wiring Boards .....	22
2-1.	Rear Cover Removal .....	12		* C Board .....	27
2-2.	A PWB Removal [1] .....	12		* A Board .....	29
2-3.	A PWB Removal [2] .....	12	5-4.	Semiconductors .....	37
2-4.	Service Position .....	12	5-5.	IC Blocks .....	39
2-5.	Wire Dressing .....	12	<b>6. EXPLODED VIEWS</b>		
2-6.	Picture Tube Removal .....	13	6-1.	Chassis .....	40
			6-2.	Picture Tube .....	41
			<b>7. ELECTRICAL PARTS LIST</b>		42

## CAUTION

**SHORT CIRCUIT THE ANODE OF THE PICTURE TUBE AND THE ANODE CAP TO THE METAL CHASSIS, CRT SHIELD, OR THE CARBON PAINTED ON THE CRT, AFTER REMOVAL OF THE ANODE CAP.**

## WARNING !!

AN ISOLATION TRANSFORMER SHOULD BE USED DURING ANY SERVICE WORK TO AVOID POSSIBLE SHOCK HAZARD DUE TO LIVE CHASSIS, THE CHASSIS OF THIS RECEIVER IS DIRECTLY CONNECTED TO THE POWER LINE.

## SAFETY-RELATED COMPONENT WARNING !!

COMPONENTS IDENTIFIED BY SHADING AND MARKED  $\Delta$  ON THE SCHEMATIC DIAGRAMS, EXPLODED VIEWS AND IN THE PARTS LIST ARE CRITICAL FOR SAFE OPERATION. REPLACE THESE COMPONENTS WITH SONY PARTS WHOSE PART NUMBERS APPEAR AS SHOWN IN THIS MANUAL OR IN SUPPLEMENTS PUBLISHED BY SONY.

## ATTENTION

**APRES AVOIR DECONNECTE LE CAP DE L'ANODE, COURT-CIRCUITER L'ANODE DU TUBE CATHODIQUE ET CELUI DE L'ANODE DU CAP AU CHASSIS METALLIQUE DE L'APPAREIL, OU AU COUCHE DE CARBONE PEINTE SUR LE TUBE CATHODIQUE OU AU BLINDAGE DU TUBE CATHODIQUE.**

## ATTENTION !!

AFIN D'EVITER TOUT RISQUE D'ELECTROCUTION PROVENANT D'UN CHÂSSIS SOUS TENTION, UN TRANSFORMATEUR D'ISOLEMENT DOIT ETRE UTILISÉ LORS DE TOUT DÉPANNAGE LE CHÂSSIS DE CE RÉCEPTEUR EST DIRECTMENT RACCORDÉ À L'ALIMENTATION SECTEUR.

## ATTENTION AUX COMPOSANTS RELATIFS À LA SÉCURITÉ!!

LES COMPOSANTS IDENTIFIÉS PAR UNE TRAME ET PAR UNE MARQUE  $\Delta$  SUR LES SCHÉMAS DE PRINCIPE, LES VUES EXPLOSÉES ET LES LISTES DE PIÈCES SONT D'UNE IMPORTANCE CRITIQUE POUR LA SÉCURITÉ DU FONCTIONNEMENT, NE LES REMPLACER QUE PAR DES COMPOSANTS SONY DONT LE NUMÉRO DE PIÈCE EST INDIQUÉ DANS LE PRÉSENT MANUEL OU DANS DES SUPPLÈMENTS PUBLIÉS PAR SONY.

ITEM MODEL	Television System	Channel Coverage	Color System
French	B/G/H, L,I	VHF : E2-E12, F2-F10 UHF : E21-E69 CABLE TV : S01-S03, S1-S20, B-Q HYPER : S21-S41 L F02-F10, F21-F69 I UHF : B21-B69	PAL, SECAM NTSC4.43, NTSC3.58 (VIDEO IN)
Spanish	B/G/H	VHF : E2-E12 UHF : E21-E69 CABLE TV : S01-S03, S1-S20, B-Q HYPER : S21-S41	PAL, SECAM NTSC4.43, NTSC3.58 (VIDEO IN)
OIRT	B/G/H, D/K	VHF : E2-E12, R01-R12 UHF : E21-E69, R21-R69 CABLE TV : S01-S03, S1-S20, B-Q HYPER : S21-S41	PAL, SECAM NTSC4.43, NTSC3.58 (VIDEO IN)
UK	I	I : UHF B21-B69	PAL, SECAM NTSC4.43, NTSC3.58 (VIDEO IN)

Model	KV-14LT1/LM1B	KV-14LT1/LM1E	KV-14LT1/LM1K	KV-14LT1/LM1U
Power Consumption	42W	42W	42W	54W

Picture Tube	Flat Display FD Trinitron Approx. 37cm (14 inches) (Approx. 34 cm picture measured diagonally) 90 degree deflection	Sound output	1x6W (Music Power) 1x3W (RMS Mono)
<b>Input/Output Terminals [REAR]</b>		Power Requirements	220 - 240V
1: 21-pin Euro connector (CENELEC standard)	Inputs for Audio and Video signals. Inputs for RGB. Outputs of TV Video and Audio signals.	Dimensions	Approx 393x358x415mm
<b>Input/Output Terminals [FRONT]</b>		Weight	Approx 11.5kg
2: Video input	phono jack	Supplied Accessories	KV-14LT1: RM-887 Remote Commander (1) KV-14LM1: RM-889 Remote Commander (1) IEC designated R6 battery (2)
2: Audio input	phono jack	Other Features	KV-14LT1: Teletext, Sleep Timer, Smartlink, TV system Autodetection KV-14LM1: Sleep Timer, TV system Autodetection
Headphone jack	stereo mini jack	Remote control system	Infrared control
		Power requirements	3V dc 2 batteries IEC designation R6 (size AA)
<b>Design and specifications are subject to change without notice.</b>			

Model Name Item	KV-14LT1B	KV-14LT1E	KV-14LT1K	KV-14LT1U	KV-14LM1B	KV-14LM1E	KV-14LM1K	KV-14LM1U
Pal Comb	OFF	OFF	OFF	OFF	OFF	OFF	OFF	OFF
PIP	OFF	OFF	OFF	OFF	OFF	OFF	OFF	OFF
RGB Priority	ON	ON	OFF	ON	ON	ON	OFF	ON
Woofer Box	OFF	OFF	OFF	OFF	OFF	OFF	OFF	OFF
Scart 1	ON	ON	ON	ON	ON	ON	ON	ON
Scart 2	OFF	OFF	OFF	OFF	OFF	OFF	OFF	OFF
Front in (3)	OFF	OFF	OFF	OFF	OFF	OFF	OFF	OFF
Scart 4	OFF	OFF	OFF	OFF	OFF	OFF	OFF	OFF
Projector	OFF	OFF	OFF	OFF	OFF	OFF	OFF	OFF
AKB in 16:9 mode	OFF	OFF	OFF	OFF	OFF	OFF	OFF	OFF
Norm B/G	ON	ON	ON	OFF	ON	ON	ON	OFF
Norm I	ON	OFF	OFF	ON	ON	OFF	OFF	ON
Norm D/K	ON	OFF	ON	OFF	ON	OFF	ON	OFF
Norm AUS	OFF	OFF	OFF	OFF	OFF	OFF	OFF	OFF
Norm L	ON	OFF	OFF	OFF	ON	OFF	OFF	OFF
Norm SAT	OFF	OFF	OFF	OFF	OFF	OFF	OFF	OFF
Norm M	OFF	OFF	OFF	OFF	OFF	OFF	OFF	OFF
Teletext	ON	ON	ON	ON	OFF	OFF	OFF	OFF
Nicam Stereo	OFF	OFF	OFF	OFF	OFF	OFF	OFF	OFF

### WARNING (UK Models only)

The flexible mains lead is supplied connected to a **B.S. 1363** fused plug having a fuse of **5 AMP** rating. Should the fuse need to be replaced, use a **5 AMP FUSE** approved by ASTA to **BS 1362**, ie one that carries the  mark.

IF THE PLUG SUPPLIED WITH THIS APPLIANCE IS NOT SUITABLE FOR THE OUTLET SOCKETS IN YOUR HOME, IT SHOULD BE CUT OFF AND AN APPROPRIATE PLUG FITTED. THE PLUG SEVERED FROM THE MAINS LEAD MUST BE DESTROYED AS A PLUG WITH BARED WIRES IS DANGEROUS IF ENGAGED IN A LIVE SOCKET.

When an alternative type of plug is used, it should be fitted with a **5 AMP FUSE**, otherwise the circuit should be protected by a **5 AMP FUSE** at the distribution board.

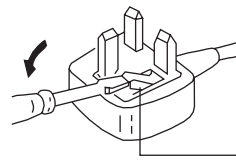

How to replace the fuse.  
Open the fuse compartment with a screwdriver blade and replace the fuse.



## 21 pin connector

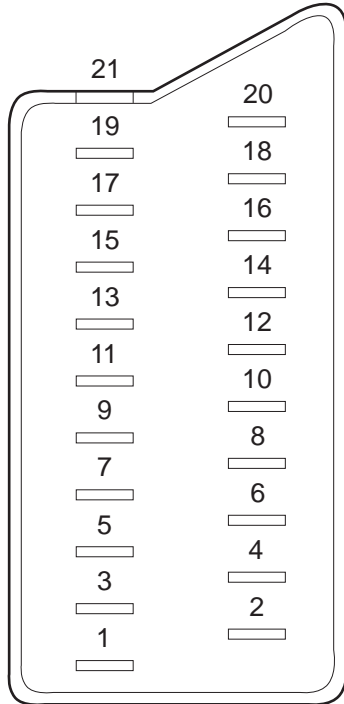

Pin No	1	2	4	Signal	Signal level
1	○	○	○	Audio output B (right)	Standard level : 0.5V rms Output impedance : Less than 1kohm*
2	○	○	○	Audio output B (right)	Standard level : 0.5V rms Output impedance : More than 10kohm*
3	○	○	○	Audio output A (left)	Standard level : 0.5V rms Output impedance : Less than 1kohm*
4	○	○	○	Ground (audio)	
5	○	○	○	Ground (blue)	
6	○	○	○	Audio input A (left)	Standard level : 0.5V rms Output impedance : More than 10kohm*
7	○	●	●	Blue input	0.7 +/- 3dB, 75 ohms positive
8	○	○	○	Function select (AV control)	High state (9.5-12V) : Part mode Low state (0-2V) : TV mode Input impedance : More than 10K ohms Input capacitance : Less than 2nF
9	○	○	○	Ground (green)	
10	○	○	○	Open	
11	○	●	●	Green	Green signal : 0.7 +/- 3dB, 75 ohms, positive
12	○	○	○	Open	
13	○	○	○	Ground (red)	
14	○	○	○	Ground (blanking)	
15	○	-	-	Red input	0.7 +/- 3dB, 75 ohms, positive
	-	○	○	(S signal Chroma input)	0.3 +/- 3dB, 75 ohms, positive
16	○	●	●	Blanking input (Ys signal)	High state (1-3V) Low state (0-0.4V) Input impedance : 75 ohms
17	○	○	○	Ground (video output)	
18	○	○	○	Ground (video input)	
19	○	○	○	Video output	1V +/- 3dB, 75ohms, positive sync 0.3V (-3+10dB)
20	○	-	-	Video input	1V +/- 3dB, 75ohms, positive sync 0.3V (-3+10dB)
	-	○	○	Video input Y (S signal)	1V +/- 3dB, 75ohms, positive sync 0.3V (-3+10dB)
21	○	○	○	Common ground (plug, shield)	

○ Connected      ● Not Connected (open) \* at 20Hz - 20kHz

## Rear Connection Panel

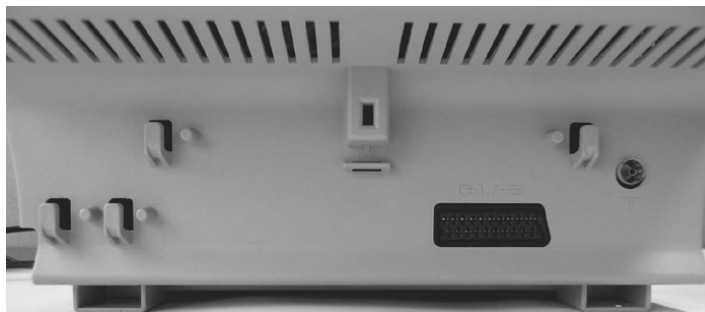

## Front Connection Panel



# FE-2 SELF DIAGNOSTIC SOFTWARE

The identification of errors within the FE-2 chassis is triggered in one of two ways :- 1: Busy or 2: Device failure to respond to IIC. In the event of one of these situations arising the software will first try to release the bus if busy (Failure to do so will report with a continuous flashing LED) and then communicate with each device in turn to establish if a device is faulty. If a device is found to be faulty the relevant device number will be displayed through the LED (Series of flashes which must be counted) See table 1., non fatal errors are reported using this method. Each time the software detects an error it is stored within the NVM. See Table 2.

**Table 1**

Error Message	LED Code
No error	00
Reserved	01
OCP ( Over Current Protection )	02
Reserved	03
No Vertical Sync	04
Unstable AKB	05
IIC bus clock and/or data lines low at power on	06
NVM no IIC bus acknowledge at power on	07
Not Used	08
Tuner no acknowledge at power on	09
Not used	10
Jungle controller no acknowledge at Power ON	11

### How to enter into Table 2

1. Turn on the main power switch of the TV set and enter into the 'Standby Mode'.
2. Press the following sequence of buttons on the Remote Commander.

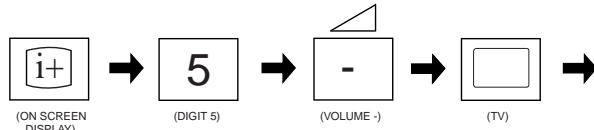

3. The following table will be displayed indicating the error count.

### Flash Timing Example : e.g. error number 3

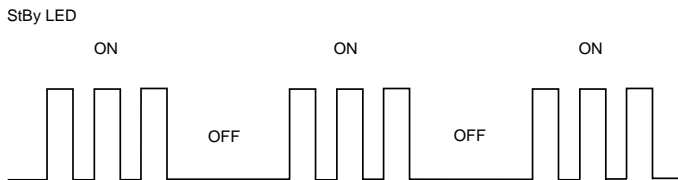

**Table 2**

ERROR MENU			
E02	OCP	(0, 255)	0
E03	OVP N/A	(0, 255)	0
E04	VSYNC	(0, 255)	0
E05	IKR	(0, 255)	0
E06	IIC	(0, 255)	0
E07	NVM	(0, 255)	0
E08	JUNGLE	(0, 255)	0
E09	TUNER	(0, 255)	0
E10	SOUNDP	(0, 255)	0
E11	8V	(0, 255)	0
<b>WORKING TIME</b>			
HOURS			0
MINUTES			0

**Note:** To clear the error count data press '80' on the Remote commander.

The operating instructions mentioned here are partial abstracts from the 'Operating Instruction Manual'. The page numbers of the 'Operating Instruction Manual' remain as in the manual.

## Switching On the TV and Automatically Tuning

**1** The first time you switch on your TV, a sequence of menu screens appear on the TV enabling you to: 1) choose the language of the menu screen, 2) choose the country in which you wish to operate the TV, 3) search and store all available channels (TV Broadcast) and 4) change the order in which the channels (TV Broadcast) appear on the screen. However, if you need to change the language menu, change or repeat the tuning (e.g. when you move house) or rearrange again the order of the channels afterwards, you can do that by selecting the appropriate menu in the **Set Up**. For more information, refer to the "Menu Guide" section of this instruction manual. You can also do that by pressing the Auto Start Up Button **▶▶** on the TV set.

**1** Connect the TV plug to the mains socket (220-240V AC, 50Hz)

Press the **On/off** button on the TV set to turn on the TV. The first time you press this button, a **Language** menu displays automatically on the TV screen.

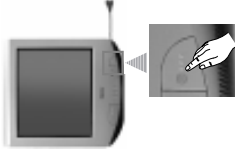

**2** Press the **Left** or **Right** button on the remote control to select the language, then press the **OK** button to confirm your selection. From now on all the menus will appear in the selected language.

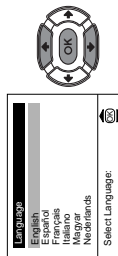

**3** The **Country** menu appears automatically on the TV screen. Press the **Left** or **Right** button to select the country in which you will operate the TV set, then press the **OK** button to confirm your selection.

**1** Select "...", instead of a country does not appear in the list.

- If the country in which you want to use the TV set does not appear in the list.
- If you do not want your channels (TV Broadcast) stored in a given channel sequence starting from programme position 1.

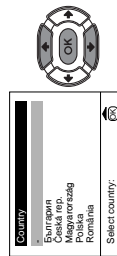

**4** The **Auto Tuning** menu appears on the screen. Press the **OK** button to select **Yes**.

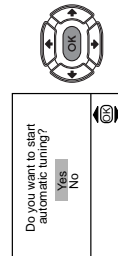

continued...

First Time Operation

## SECTION 1 GENERAL

**5** A new menu appears on the screen asking you to check that the aerial is connected. Ensure the aerial is connected and then press the **OK** button to start the automatic tuning.

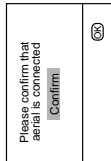

**1** The TV starts to automatically search and store all available channels (TV Broadcast) for you.

**2** This procedure could take some minutes. Please be patient and do not press any button. Otherwise the automatic tuning will not be completed.



**6** After all available channels are captioned and stored, the **Programme Sorting** menu appears automatically on the screen enabling you to change the order in which the channels appear on the screen.

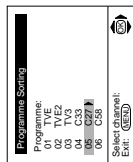

a) If you do not wish to change the channel order, go to step 7.

b) If you wish to change the channel order:

1 Press the **Left** or **Right** button to select the programme number with the channel (TV Broadcast) you wish to rearrange, then press the **Left** button.

2 Press the **Left** or **Right** button to select the new programme number position for your selected channel (TV Broadcast), then press **Left**.

3 Repeat steps b)1 and b)2 if you wish to change the order of the other channels.

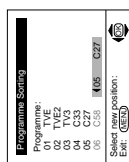

**7** Press the **MENU** button to remove the menu from the screen.



**1** Your TV is now ready for use

# Introducing and Using the Menu System

**i** Your TV uses an on-screen menu system to guide you through the operations. Use the following buttons on the Remote Control to operate the menu system:

**1** Press the **MENU** button to switch the first level menu on.



**2** To highlight the desired menu or option, press **↔** or **↕**.

- To enter to the selected menu or option, press **↵**.

- To return to the last menu or option, press **←**.

- To alter settings of your selected option, press **↔** / **↕** or **↵**.

- To confirm and store your selection, press **OK**.



**3** Press the **MENU** button to remove the menu from the screen.



## Menu Guide

Level 1

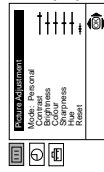

Level 3 / Function

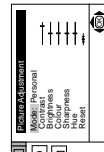

**PICTURE ADJUSTMENT**  
The "Picture Adjustment" menu allows you to alter the picture adjustments.

To do that: after selecting the item you want to alter, press **↔**, then press repeatedly **↔** / **↕** / **↵** or **↵** to adjust it and finally press **OK** to store the new adjustment.

This menu also allows you to customise the picture mode based on the programme you are watching:

- ↵ **Personal** (for individual settings).
- ↵ **Live** (for live broadcast programmes).
- ↵ **Movie** (for films).

- **Brightness, Colour and Sharpness** can only be altered if "Personal" mode is selected.
- **Hue** is only available for NTSC colour signal (e.g. USA video tapes).

- Select **Reset** and press **OK** to reset the picture to the factory preset levels.

continued...

Menu System | 9

Level 1

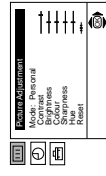

Level 2

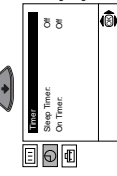

Level 3 / Function

### SLEEP TIMER

The "Sleep Timer" option in the "Timer" menu allows you to select a time period for the TV to switch itself automatically into the standby mode.

To do that: after selecting the option press **↵**, then press **↔** or **↕** to set the time period delay (max. of 4 hours) and finally press **OK** to store.

- While watching the TV, you can press the **(⏻)** button on the remote control to display the time remaining.
- One minute before the TV switches itself into standby mode, the time remaining is displayed on the TV screen automatically.

### ON TIMER

The "On Timer" option in the "Timer" menu allows you to select a time period for the TV to switch itself automatically on from standby mode.

To do that: after selecting the option press **↵**, then press **↔** or **↕** to set the time period delay (max. 12 hours) and press **OK** to store. Finally press the standby button **⏻** on the remote control. After the selected length of time the TV switches on automatically.

- The standby indicator **⏻** on the TV set flashes regularly to indicate that "On Timer" is active.
- Any loss of power will cause these settings to be cleared.

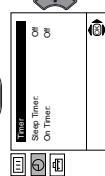
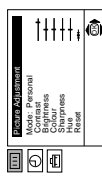

### LANGUAGE / COUNTRY

The "Language/Country" option in the "Set Up" menu allows you to select the language that the menus are displayed in. It also allows you to select the country in which you wish to operate the TV set.

To do that: after selecting the option, press **↵** and then proceed in the same way as in the steps 2 and 3 of the section "Switching On the TV and Automatically Tuning".

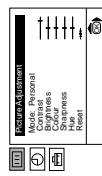

continued...

Menu System

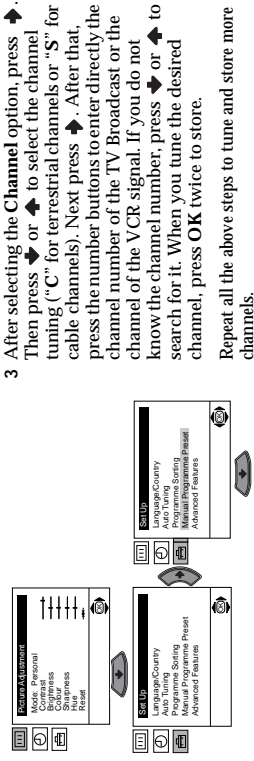

**3** After selecting the **Channel** option, press **↔**. Then press **↔** or **↔** to select the channel tuning ("C" for terrestrial channels or "S" for cable channels). Next press **↔**. After that, press the number buttons to enter directly the channel number of the TV Broadcast or the channel of the VCR signal. If you do not know the channel number, press **↔** or **↔** to search for it. When you tune the desired channel, press **OK** twice to store.

Repeat all the above steps to tune and store more channels.

**b)** Normally the automatic fine tuning (AFT) is operating, however you can manually fine tune the TV to obtain a better picture reception in the case that the picture is distorted.

To do that: while watching the channel (TV Broadcast) you wish to fine tune, select the **AFT** option and press **↔**. Next press **↔** or **↔** to adjust the fine tuning between -15 and +15. Finally press **OK** twice to store.

**c)** Skip any unwanted programme numbers when they are selected with the **PROGR +/-** buttons.

To do that: Highlighting the **Programme** option, press the **PROGR +/-** button to select the programme number you want to skip. When the programme you want to skip appears on the screen, select the **Skip** option and press **↔**. Next press **↔** or **↔** to select **Yes**. Finally press **OK** twice to confirm and store.

To cancel this function afterwards, select "No" instead of "Yes" in the step above.

**d)** Label a channel using up to five characters. To do that: Highlighting the **Programme** option, press the **PROGR +/-** button to select the programme number with the channel you wish to name. When the programme you want to name appears on the screen, select the **Label** option and press **↔**. Next press **↔** or **↔** to select a letter, number or "." for a blank. Press **↔** to confirm this character. Select the other four characters in the same way. After selecting all the characters, press **OK** twice to store.

**AUTO TUNING**

The "Auto Tuning" option in the "Set Up" menu allows you to automatically search for and store all available TV channels.

To do that: after selecting the option, press **↔** and then proceed in the same way as in TV steps 4 and 5 of the section "Switching On the TV and Automatically Tuning".

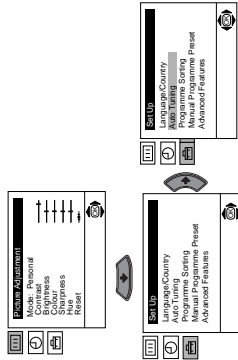

**PROGRAMME SORTING**

The "Programme Sorting" option in the "Set Up" menu allows you to change the order in which the channels (TV Broadcast) appear on the screen.

To do that: after selecting the option, press **↔** and then proceed in the same way as in step 6 b) of the section "Switching On the TV and Automatically Tuning".

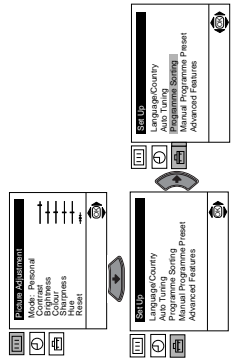

**MANUAL PROGRAMME PRESET**

The "Manual Programme Preset" option in the "Set Up" menu allows you to:

**a)** Preset channels or a video input source one by one to the programme order of your choice. To do that:

**1** After selecting the "Manual Programme Preset" option, press **↔** then with **Programme** option highlighted press **↔**. Press **↔** or **↔** to select on which programme number you want to preset the channel (for VCR, select programme number "0"). Then press **↔**.

**2** After selecting the **System** option, press **↔**. Then press **↔** or **↔** to select the TV Broadcast system (B/G for western European countries or D/K for eastern European countries). Then press **↔**.

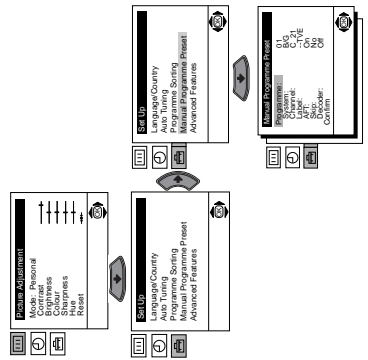

continued...

continued...

## Teletext

**1** Teletext is an information service transmitted by most TV stations. The index page of the teletext service (usually page 100) gives you information on how to use the service. To operate teletext, use the remote control buttons as indicated below.

**A** Make sure to use a channel (TV Broadcast) with a strong signal, otherwise teletext errors may occur.

To Switch On Teletext :

After select the channel (TV Broadcast) which carries the teletext you wish to view, press **100**.

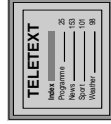

To Select a Teletext page:

Input 3 digits for the page number, using the numbered buttons.

- If you have made a mistake, retype the correct page number.
- If the counter on the screen continues searching, it is because this page is not available. In that case, input another page number

To access the next or preceding page:

Press **PROGR + 100** or **PROGR - 100**.

To superimpose teletext on to the TV:

Whilst you are viewing teletext, press **100**. Press it again to cancel teletext mode.

To freeze a teletext page:

Some teletext pages have sub-pages which follow on automatically. To stop them, press **100/100**. Press it again to cancel the freeze.

To reveal concealed information (e.g. answer to a quiz):

Press **100/100**. Press it again to conceal the information.

To Switch Off Teletext:

Press **100**.

## Fastext

**1** Fastext service lets you access pages with one button push.

While you are in Teletext mode and Fastext is broadcast, a colour coded menu appears at the bottom of the teletext page. Press the colour button (red, green, yellow or blue) to access the corresponding page.

## Connecting Optional Equipment

**1** Using the following instructions, you can connect a wide range of optional equipment to your TV set. (Connecting cables are not supplied).

### Connecting a VCR:

To connect a VCR, please refer to the section "Connecting the aerial and VCR" of this instruction manual. We recommend you connect your VCR using a scart lead. If you do not have a scart lead, tune in the VCR test signal to TV programme number "0" by using "Manual Programme Preset" option. (for details how to manual programme, see page 11, step a).

Also refer to your VCR instruction manual to find out how to find the output channel of your VCR.

If you have connected a decoder to a VCR which supports

### Smartlink feature:

Select the "Manual Programme Preset" option in the "Set Up" menu and after entering in the "Decoder" option, select "On" (by using **100** or **100**) to each scrambled channel.

\*This option is only available depending the country you have selected in the "Country" menu.

\*\* "PlayStation" is a product of Sony Computer Entertainment, Inc.

\*\* "PlayStation" is a trademark of Sony Computer Entertainment, Inc.

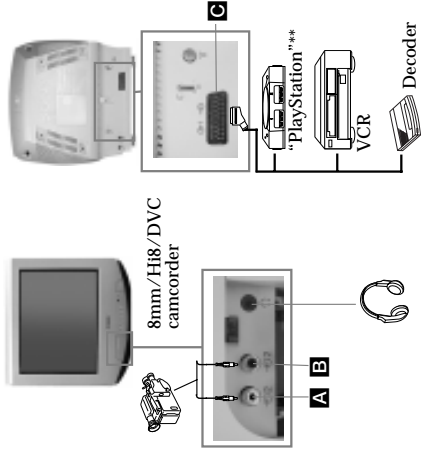

## Using Optional Equipment

- 1 Connect your equipment to the designated TV socket, as indicated above.
- 2 To watch the picture of the connected equipment, press the **100** button repeatedly until the correct input symbol appears on the screen.

Symbol Input Signals

**100** 1

• Audio / video input signal through the Scart connector **C**

**100** 2

• RGB input signal through the Scart connector **C**. This symbol appears only if a RGB source has been connected.

**100** 2

• Video input signal through the phono socket **A** and Audio input signal through **B**.

- 3 Switch on the connected equipment.

- 4 Press **100** button on the remote control to return to the normal TV picture.

## Specifications







<b>TV system:</b> B/G/H, D/K	<b>Sound Output:</b> • KV-21LTIK: 1 x 8 W (music power) 1 x 4 W (RMS Mono) • KV-14LTIK: 1 x 6 W (music power) 1 x 3 W (RMS Mono)
<b>Colour system:</b> PAL, SECAM NTSC 3.58, 4.43 (only Video In)	<b>Power Consumption:</b> • KV-21LTIK: 55 W • KV-14LTIK: 42 W
<b>Channel Coverage:</b> VHF: E2-E12 UHF: E21-E69 CATV: S1-S20 HYPER: S21-S41 D/K: R1-R12, R21-R69	<b>Standby Power Consumption:</b> ≤ 0.55 W
<b>Picture Tube:</b> Flat Display FD Trinitron	<b>Dimensions (w x h x d) :</b> • KV-21LTIK: Approx. 514 x 478 x 487 mm. • KV-14LTIK: Approx. 393 x 358 x 415 mm.
<b>Rear Terminals</b> ☞ 1/☞ 21-pin scart connector (CENELEC standard) including audio/video input, RGB input, TV audio/video output.	<b>Weight:</b> • KV-21LTIK: Approx. 24 Kg. • KV-14LTIK: Approx. 11.5 Kg.
<b>Front Terminals</b> ☞ 2 video input – phono jack ☞ 2 audio input – phono jack ☞ headphones jack	<b>Accessories supplied:</b> 1 Remote Control (RM-887) 2 Batteries (IEC designated) 1 Aerial (only for KV-14LTIK)
	<b>Other features:</b> • Teletext, Fastext, TOPtext • Sleep Timer • Wake UP Timer • Smartlink (direct link between your TV set and a compatible VCR. For more information on Smartlink, please refer to the Instruction Manual of your VCR). • TV system Autodetection.

Design and specifications are subject to change without notice.

Ecological Paper- Totally Chlorine Free 

## Troubleshooting

 Here are some simple solutions to the problems which may affect the picture and sound.

Problem	Solution
No picture (screen is dark) and no sound.	<ul style="list-style-type: none"> <li>• Check the aerial connection.</li> <li>• Plug the TV in and press the  button on the front of TV.</li> <li>• If the standby indicator  is on, press  button on the remote control.</li> </ul>
Poor or no picture (screen is dark), but good sound.	<ul style="list-style-type: none"> <li>• Using the menu system, select the "Picture Adjustment" menu and select "Reset" to return to the factory settings.</li> </ul>
No picture or no menu information from the equipment connected to the Scart connector.	<ul style="list-style-type: none"> <li>• Check that the optional equipment is on and press the  button repeatedly on the remote control until the correct input symbol is displayed on the screen.</li> </ul>
Good picture, no sound.	<ul style="list-style-type: none"> <li>• Press the  +/- button on the remote control.</li> </ul>
No colour on colour programmes.	<ul style="list-style-type: none"> <li>• Using the menu system, select the "Picture Adjustment" menu and select "Reset" to return to factory settings.</li> </ul>
Distorted picture when changing programmes or selecting teletext.	<ul style="list-style-type: none"> <li>• Turn off any equipment connected to the Scart connector on the rear of the TV.</li> </ul>
Picture slanted (only for KV-21LTIK)	<ul style="list-style-type: none"> <li>• Using the menu system, select the "Picture Rotation" option in the "Advanced Features" menu to correct the picture slant.</li> </ul>
Noisy picture when viewing a TV channel.	<ul style="list-style-type: none"> <li>• Using the menu system, select the "Manual Programme Preset" menu and adjust Fine Tuning (AFT) to obtain better picture reception.</li> <li>• Using the menu system, select the "Noise Reduction" option in the "Advanced Features" menu and select "On" to reduce the noise in the picture.</li> </ul>
Remote control does not function.	<ul style="list-style-type: none"> <li>• Replace the batteries.</li> </ul>
The standby indicator  on the TV flashes even though the "On Timer"	<ul style="list-style-type: none"> <li>• Contact to your nearest Sony service centre.</li> </ul>

 In case of problems, have your TV serviced by qualified personnel. Never open the casing yourself.



## SECTION 2 DISASSEMBLY

### 2-1. Rear Cover Removal



Release the mains power cable from its securing posts. Remove the rear cover fixing screws indicated. Pull the rear cover away from the front beznet until clear of chassis.

**Note :** Use a cross-head screwdriver with a blade length of at least 200mm.

### 2-2. A Board PWB Removal [ Step 1 ]

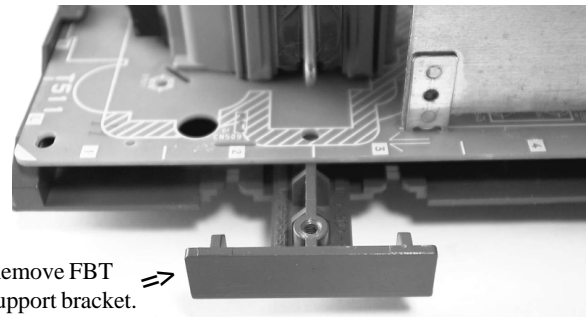

### 2-3. A Board PWB Removal [ Step 2 ]

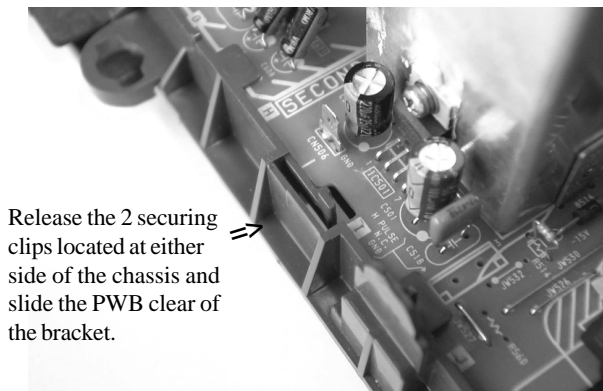

Release the 2 securing clips located at either side of the chassis and slide the PWB clear of the bracket.

### 2-5. Wire Dressing

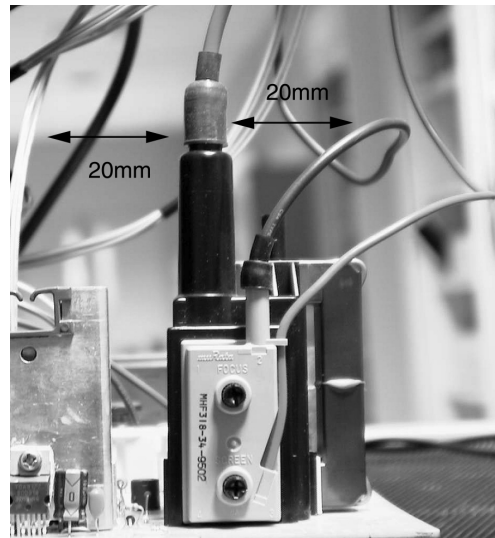

Ensure that all wires do not touch heat-sinks and high temperature hot spots. All wires must be kept at a minimum distance of 20mm away from the EHT lead.

### 2-4. Service Position

Place the A Board PWB in the position indicated to carry out servicing.

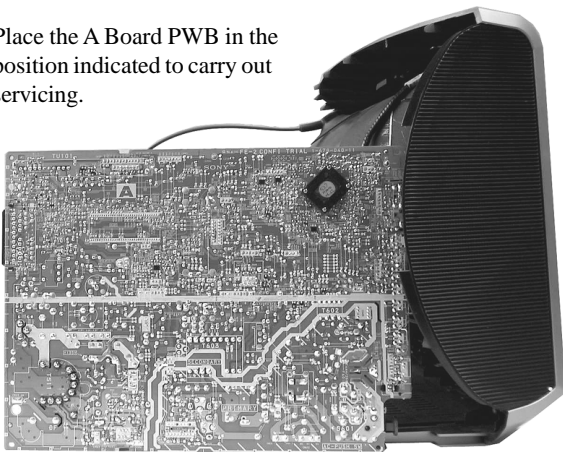



## 2-6. Picture Tube Removal

### WARNING: BEFORE REMOVING THE ANODE CAP

High voltage remains in the CRT even after the power is disconnected. To avoid electric shock, discharge CRT *before* attempting to remove the anode cap. Short between anode and CRT coated earth ground strap.

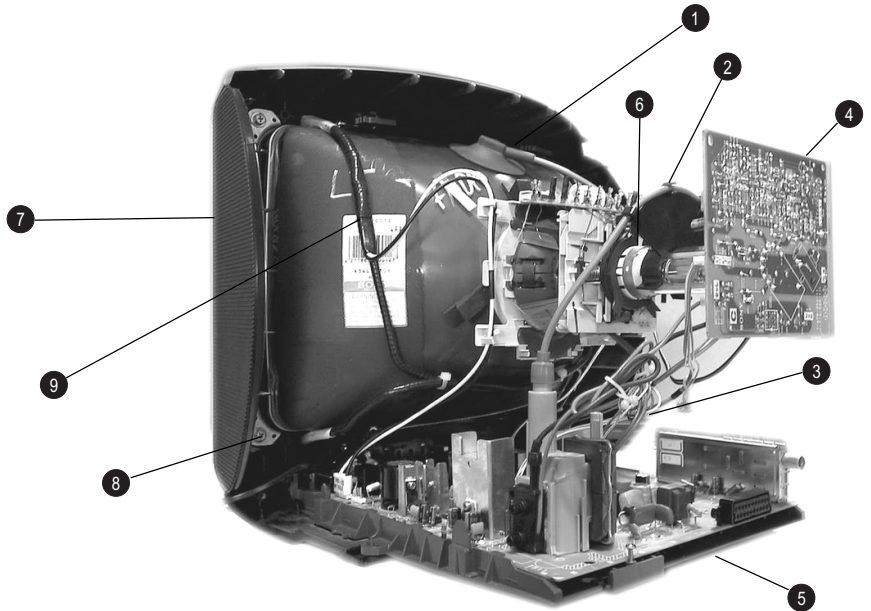
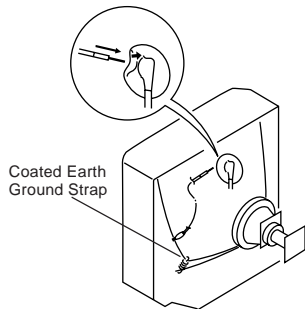

1. Discharge the anode of the CRT and remove the anode cap.
2. Release the EHT lead from its CRT support bracket.
3. Unplug all interconnecting leads from the Deflection yoke, degaussing coils and CRT grounding strap.
4. Remove the C Board from the CRT.
5. Remove the chassis assembly.
6. Loosen the Deflection yoke fixing screw and remove.
7. Place the set with the CRT face down on a cushion.
8. Unscrew the four CRT fixing screws [ located on each CRT corner ] and remove the CRT.
9. Remove the Degaussing Coils.  
Remove the CRT grounding strap and spring tentioners.  
[Take care not to handle the CRT by the neck.]

## Removal of the Anode-Cap

### \* REMOVING PROCEDURES.

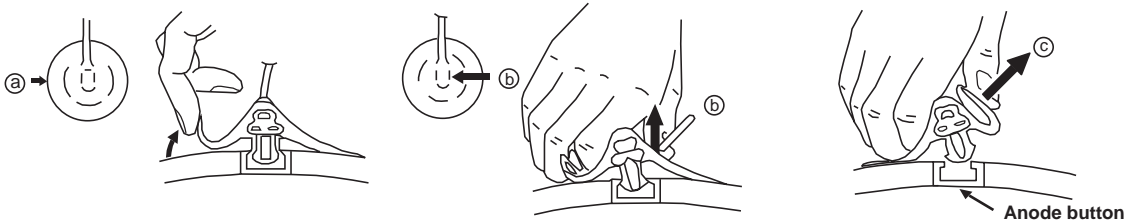

- ① Turn up one side of the rubber cap in the direction indicated by the arrow (a)
- ② Using a thumb pull up the rubber cap firmly in the direction indicated by the arrow (b)
- ③ When one side of the rubber cap is separated from the anode button, the anode-cap can be removed by turning up the rubber cap and pulling it up in the direction of the arrow (c)

## How to handle the Anode-Cap

1. To prevent damaging the surface of the anode-cap do not use sharp materials.
2. Do not apply too great a pressure on the rubber, as this may cause damage to the anode connector.
3. A metal fitting called a shatter hook terminal is fitted inside the rubber cap.
4. Do not turn the rubber foot over excessively, this may cause damage if the shatter hook sticks out.

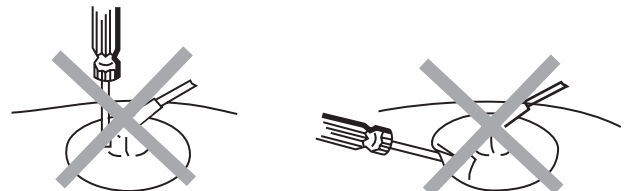

## SECTION 3 SET-UP ADJUSTMENTS

- When complete readjustment is necessary or a new picture tube is installed, carry out the following adjustments.
- Unless there are specific instructions to the contrary, carry out these adjustments with the rated power supply.
- Unless there are specific instructions to the contrary, set the controls and switches to the following settings :

Contrast ..... 80% [or remote control normal]  
 Brightness ..... 50%

**Carry out the adjustments in the following order :**

- 3-1. Beam Landing.
- 3-2. Convergence.
- 3-3. Focus.
- 3-4. White Balance.

**Note :** Test equipment required.

1. Color bar/pattern generator.
2. Degausser.
3. Oscilloscope.
4. Digital multimeter.

**Preparation:**

1. In order to reduce the influence of geomagnetism on the set's picture tube, face it in an easterly or westerly direction.
2. Switch on the set's power and degauss with the degausser.

### 3-1. Beam Landing

1. Input an all white signal from the pattern generator. Set the Contrast and Brightness to normal.
2. Set the pattern generator raster signal to Red.
3. Move the deflection yoke forward and adjust with the purity control so that the Red is at the centre and the Blue and Green take up equally sized areas on each side of the screen. [See Fig.3-1 - 3-3].
4. Move the deflection yoke backwards and adjust so that the entire screen becomes Red. [See Fig.3-1]
5. Switch the raster signal to Blue, then to Green and verify the condition.
6. When the position of the deflection yoke has been determined, fasten the deflection yoke with the screws.
7. If the beam does not land correctly in all the corners, use a magnet to correct it. [See Fig.3-4]

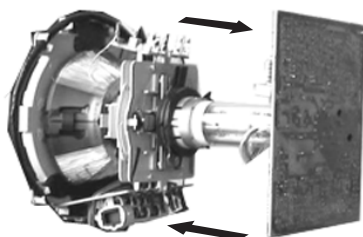
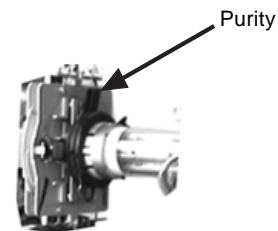

**Fig. 3-1.**

**Caution :**

High voltages are present on the Deflection yoke terminals - take care when handling the Deflection yoke whilst carrying out adjustments.

**Fig. 3-2.**



**Fig. 3-3.**

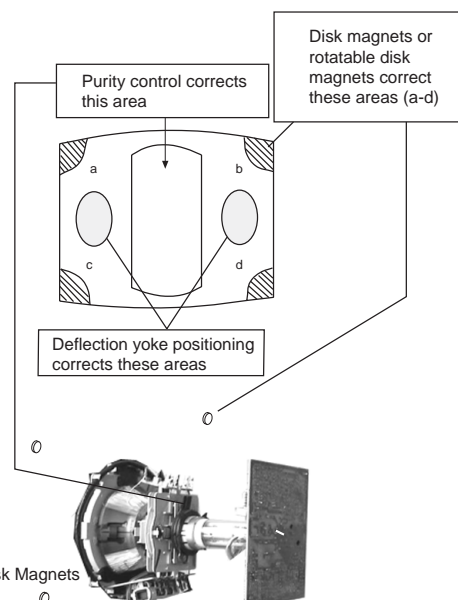
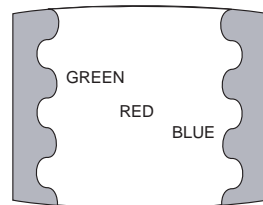

**Fig.3-4**

### 3-2. Convergence

#### Preparation:

- Before starting this adjustment, adjust the focus, horizontal size and vertical size.
- Minimize the Brightness setting.
- Input a dot pattern from the pattern generator.

#### Horizontal and Vertical Static Convergence

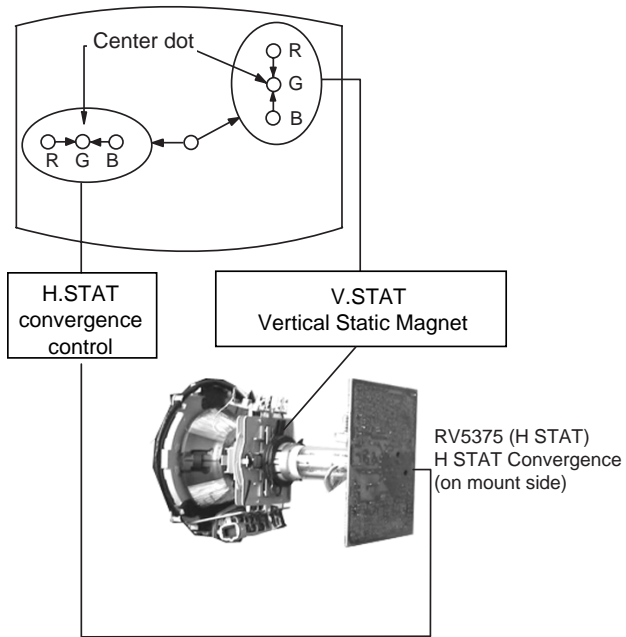
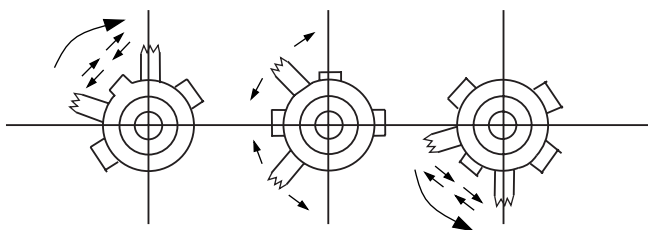

Fig.3-5

1. [Moving horizontally], adjust the H.STAT control so that the Red, Green and Blue points are on top of each other at the centre of the screen.
2. [Moving vertically], adjust the V.STAT magnet so that the Red, Green and Blue points are on top of each other at the centre of the screen.
3. If the H.STAT variable resistor is unable to bring the Red, Green and Blue points together at the centre of the screen, adjust the horizontal convergence with the H.STAT variable resistor and the V.STAT magnet in the manner indicated below.

[In this case, the H.STAT variable resistor and the V.STAT magnet influence each other].

- Tilt the V.STAT magnet and adjust the static convergence by opening or closing the V.STAT magnet.



4. If the V.STAT magnet is moved in the direction of the (a) and (b) arrows, the Red, Green and Blue points move as indicated below.

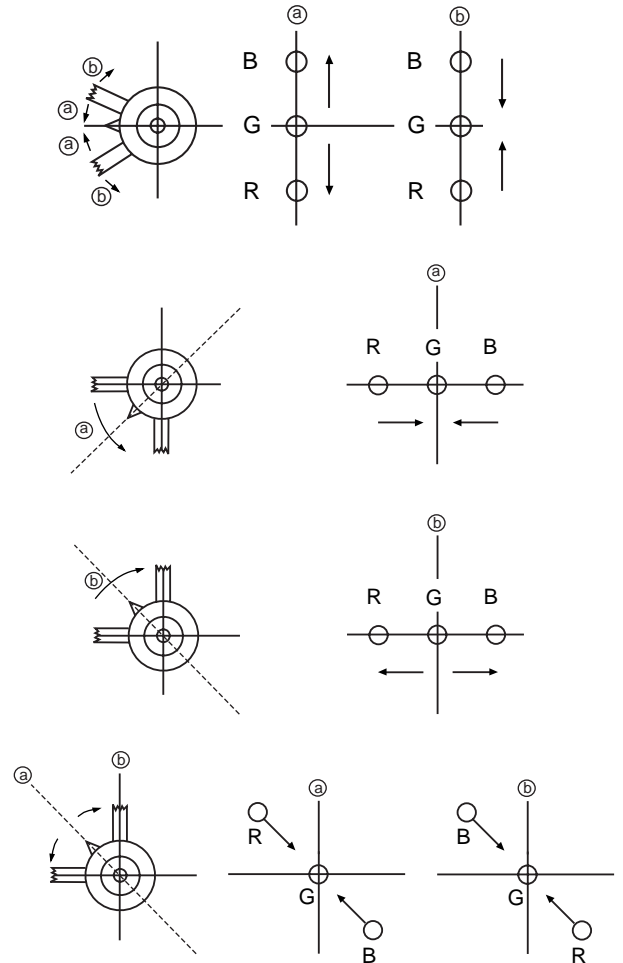

#### Operation of the BMC (Hexapole) magnet.

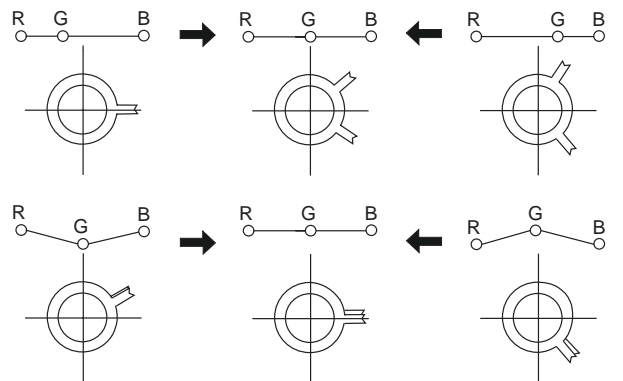

The movement of the magnets interact with each other and so the respective dot position should be monitored while carrying out this adjustment.

Use the H.STAT VR to adjust the Red, Green and Blue dots so that they coincide at the centre of the screen (by moving the dots in the horizontal direction).

## Geometry Adjustment.

### Preparation:

Before starting this adjustment, adjust the horizontal and vertical static convergence.

1. Remove the deflection yoke spacer.
2. Tilt the deflection yoke as indicated in the figure below and optimise the geometry.  
Tilting the DY Up and Down will balance the upper and lower pin adjustment.  
Tilting the DY Left and Right will balance the H-Trap adjustment.
3. Re-install the deflection yoke spacer.

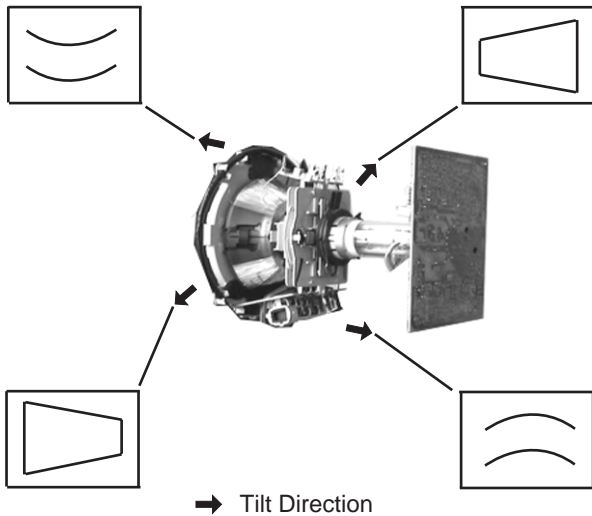

## HTIL Adjustment

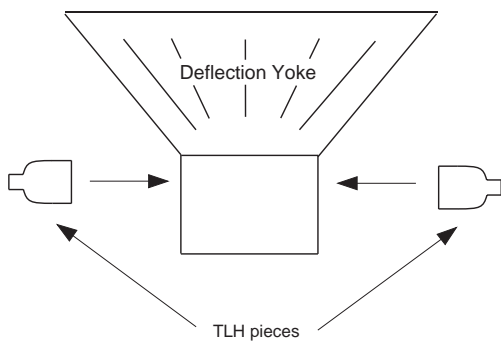

HTIL correction can be performed by adding a TLH correction assembly to the Deflection yoke.

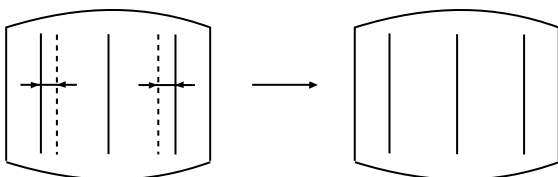

## YCH Adjustment

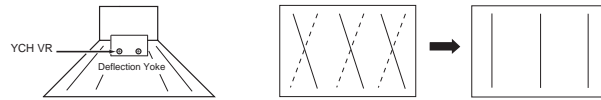

## TLV Adjustment

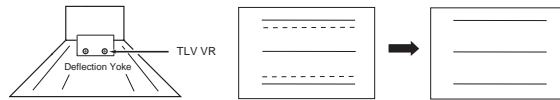

## Screen Corner Convergence

If you are unable to adjust the corner convergence properly, this can be corrected with the use of permalloy magnets.

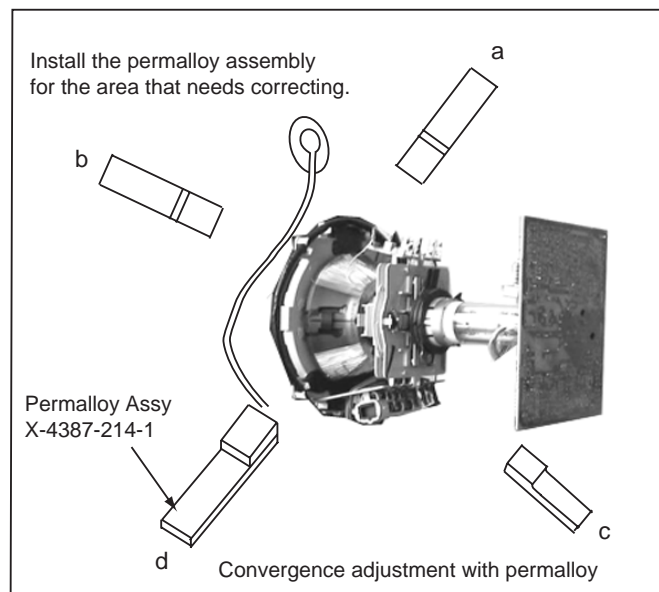
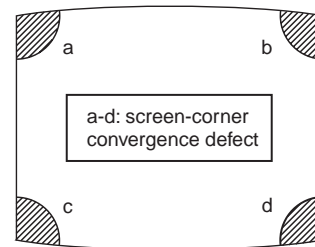

### Layout of each control

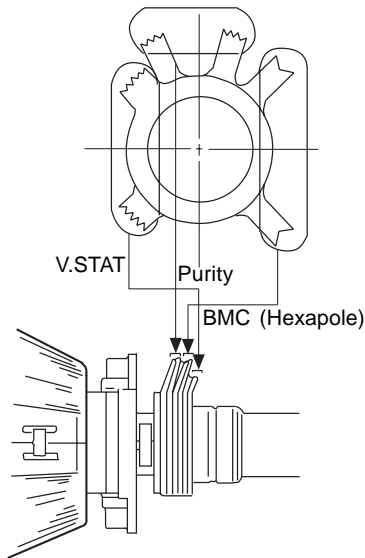

### 3-3. Focus Adjustment

1. Receive a television broadcast signal.
2. Normalize the picture setting.
3. Adjust the focus control located on the flyback transformer to obtain the best focus at the centre of the screen. Bring only the centre area of the screen into focus, the magenta-ring appears on the screen. In this case, adjust the focus to optimize the screen uniformly.

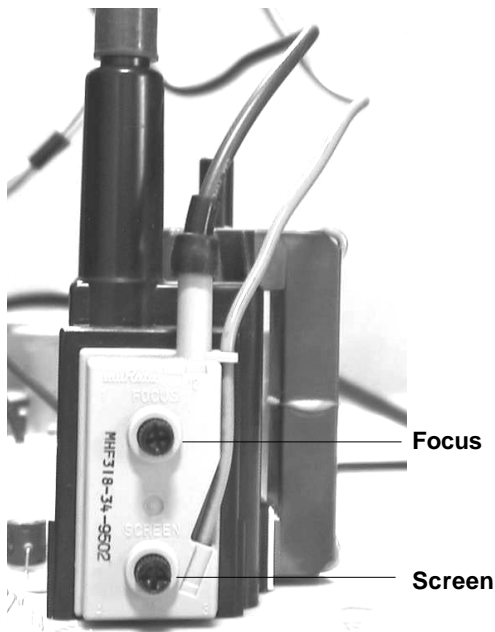

### 3-4. Screen (G2), White Balance

[Adjustment in the service mode using the remote commander]

#### G2 adjustment

1. Input a dot signal from the pattern generator.
2. Set the Picture, Brightness and Colour to minimum.
3. Apply 175V DC from an external power supply to the R, G and B cathodes of the CRT.
4. Whilst watching the picture, adjust the G2 control [SCREEN] located on the Flyback Transformer to the point just before the flyback return lines disappear.

#### White balance adjustment for TV mode

1. Input an all-white signal from the pattern generator.
2. Enter into the 'Service Mode' by pressing 'TEST', 'TEST' and 'MENU' on the Service Commander.
3. Select 'Service' from the on screen menu display and press the right arrow button on the remote commander.
4. The 'Service' menu will appear on the screen. [See Page 18]
5. Set the 'Contrast' to MAX.
6. Set the 'R-Drive' to 25.
7. Adjust the 'G-Drive' and the 'B-Drive' so that the white balance becomes optimum.
8. Press the 'OK' button to write the data for each item.
9. Set the 'Contrast' to MIN.
10. Adjust the 'G-Cutoff', and the 'R-Cutoff' with the left and right buttons on the remote commander so that the white balance becomes optimum.
11. Press the 'OK' button to write the data for each item.

# SECTION 4 CIRCUIT ADJUSTMENTS

## 4-1. Electrical Adjustments

Service adjustments to this model can be performed using the supplied Remote Commander RM-887(14LT1) or RM-889(14LM1).

### How to enter into the Service Mode

1. Turn on the main power switch and enter into the stand-by mode.
2. Press the following sequence of buttons on the Remote Commander.

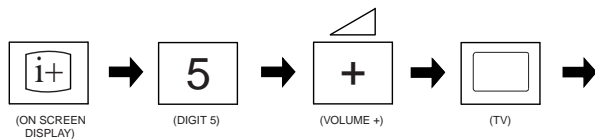

'TT—' will appear in the upper right corner of the screen.  
Other status information will also be displayed.

3. Press 'MENU' on the remote commander to obtain the following menu on the screen.

Geometry
Service
Design
Status
IF adjust
Error Menu
FE-2 Mono v1.12
Factory data 00h 00h

4. Move to the corresponding adjustment item using the up or down arrow buttons on the Remote Commander.
5. Press the right arrow button to enter into the required menu item.
6. Press the 'Menu' button on the Remote Commander to quit the Service Mode when all adjustments have been completed.

### Note :

- Before performing any adjustments ensure that the correct model has been selected in the 'Model Setting' menu.
- After carrying out the service adjustments, to prevent the customer accessing the 'Service Menu' switch the TV set OFF and then ON.

### SERVICE

Offset-R	(0, 15)	Adj
Offset-G	(0, 15)	Adj
R-Drive	(0, 63)	25
G-Drive	(0, 63)	Adj
B-Drive	(0, 63)	Adj
Peak-Freq	(0, 3)	0
Luma-Delay	(0, 15)	8
SC0	(0, 3)	3
White-Peak	(0, 15)	15
Subcont	(0, 15)	Adj
Subright	(0, 63)	Adj
Subcol	(0, 63)	Adj
Subsharp	(0, 63)	31
Br OSD	(0, 15)	11
Br TXT	(0, 15)	8

### GEOMETRY

Left-HBlk	(0, 15)	13
Right-HBlk	(0, 15)	9
V-Angle	(0, 63)	Adj
V-Bow	(0, 63)	Adj
H-Centre	(0, 63)	Adj
H-Size	(0, 63)	Adj
Pin-Amp	(0, 63)	Adj
U-Corner-Pin	(0, 63)	Adj
L-Corner-Pin	(0, 63)	Adj
Pin Phase	(0, 63)	Adj
V-Linearity	(0, 63)	Adj
V-Size	(0, 63)	Adj
S-Correction	(0, 63)	Adj
V-Centre	(0, 63)	Adj
V-Zoom	(0, 63)	25

### ERROR MENU

E02	OCP	(0, 255)	0
E03	OVP N/A	(0, 255)	0
E04	VSYNC	(0, 255)	0
E05	IKR	(0, 255)	0
E06	IIC	(0, 255)	0
E07	NVM	(0, 255)	0
E08	JUNGLE	(0, 255)	0
E09	TUNER	(0, 255)	0
E10	SOUNDP	(0, 255)	0
E11	8V	(0, 255)	0

### WORKING TIME

HOURS	0
MINUTES	0

### IF ADJUST

AGC Adjust	(0, 255)	0
Automute	(0, 255)	1
Audio Gain	(0, 255)	0
L Gating	(0, 255)	1

### Sub Brightness Adjustment

1. Input a Monoscope pattern.
2. Press 'TEST' 'TEST' 13 on the Remote Commander.
3. Adjust the 'Sub-Brightness' data so that there is barely a difference between the 0 IRE and 10 IRE signal levels.

### Sub Contrast Adjustment

1. Input a video signal that contains a small 100% white area on a black background.
2. Connect an digital voltmeter to Pin 10 of J701 [C Board].
3. Adjust the Sub-Contrast ['TT11'] to obtain a voltage of 95 +0,- 5V.

### Sub Colour Adjustment

1. Receive a PAL colour bar signal.
2. Connect an oscilloscope to Pin 3 of CN504 [A Board].
3. Enter into the 'Service' service menu.
4. Adjust the 'Sub Colour' data so that the Cyan, Magenta and Blue colour bars are of equal levels as indicated below.

**Note:**

Ensure that no signal is applied to the Antenna socket while carrying out the following IF adjustments.

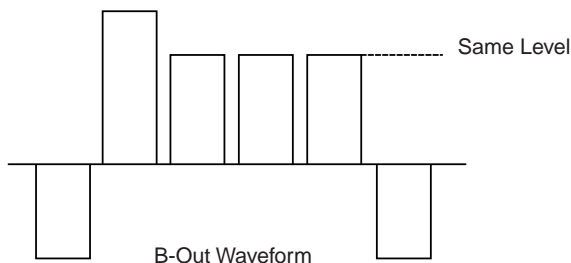

### Tuner AGC Adjustment

1. Set the "AGC adjust" register value :
  - For destination France set the value to 6.
  - All other destinations set the value to 0.
2. Receive a signal of 64dBuV / 75 ohm terminated [62dBuV / 75 ohms for B model] via the tuner antenna socket.
3. Connect a voltmeter to pin1 of TU101 [print side of A Board] or to the AGC pin of CN001 [mount side of A Board].
4. Confirm that the AGC voltage is 3.5volts +/- 0.3volts.
5. If adjustment is required, enter into the 'Test Menu'.
6. Select the 'AGC Adjust' menu item.
7. Adjust the data using the left and right arrow buttons on the Remote Commander to obtain a voltage of 3.5V +/- 0.3V.

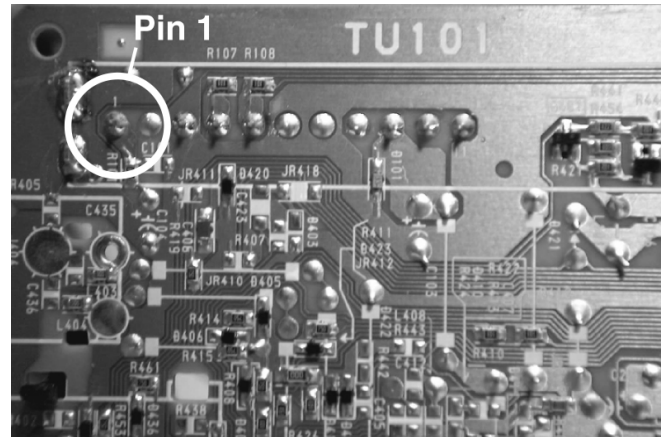

[ Print side of A board ]

### Deflection System Adjustment

1. Enter into the 'Geometry' service menu.
2. Select and adjust each item in order to obtain the optimum image.

#### GEOMETRY

Left-HBlk	(0, 15)	13
Right-HBlk	(0, 15)	9
V-Angle	(0, 63)	Adj
V-Bow	(0, 63)	Adj
H-Centre	(0, 63)	Adj
H-Size	(0, 63)	Adj
Pin-Amp	(0, 63)	Adj
U-Corner-Pin	(0, 63)	Adj
L-Corner-Pin	(0, 63)	Adj
Pin Phase	(0, 63)	Adj
V-Linearity	(0, 63)	Adj
V-Size	(0, 63)	Adj
S-Correction	(0, 63)	Adj
V-Centre	(0, 63)	Adj
V-Zoom	(0, 63)	25



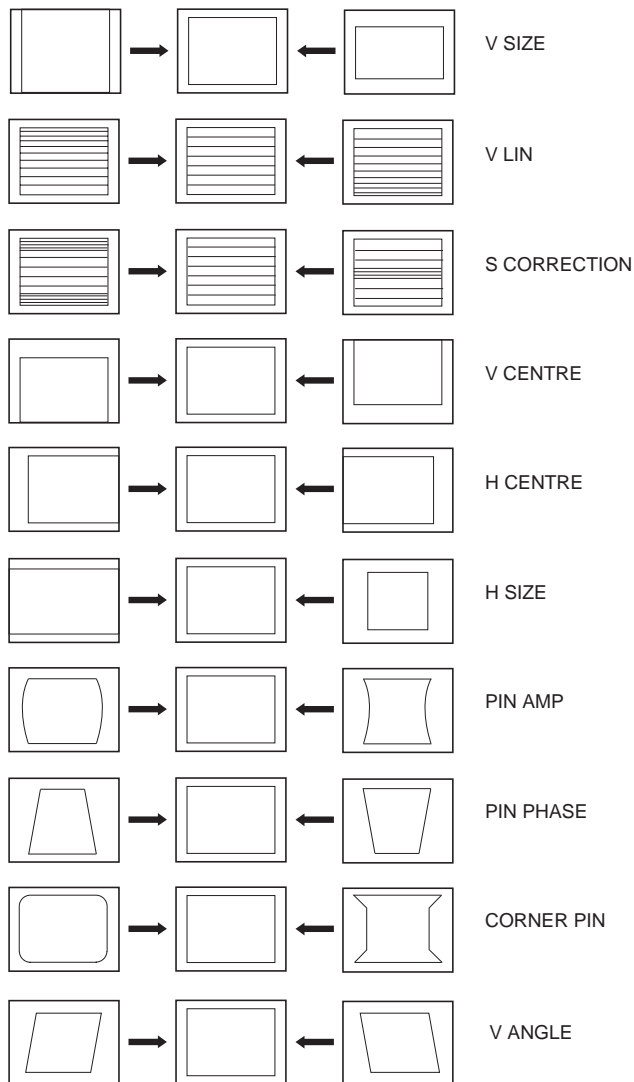

## 4-2. TEST MODE 2:

Is available by pressing the 'TEST' button twice, OSD 'TT' appears. The functions described below are available by selecting the two numbers. To release the 'Test mode 2', press 00, 10, 20 ... twice or switch the TV set into Stand-by mode. In 'TT Menu' mode, it is possible to remove the Menu from the screen by pressing the Speaker Off button once. Pressing the Speaker OFF button a second time will cause the Menu to reappear. The function is kept even when the menu is not displayed on screen !!

00	'TT' mode off
01	Picture maximum
02	Picture minimum
03	Set speaker/headphone Volume to 35%
04	Set speaker/headphone Volume to 50%
05	Set speaker/headphone Volume to 65%
06	Set speaker/headphone Volume to 80%
07	Ageing mode
08	Shipping Condition
11	Sub picture adjustment
12	Sub colour adjustment
13	Sub Brightness adjustment
14	Text H Position adjustment
15	Picture Rotation Test
16	Picture level 50%
19	Toggle Factory Mode
21	Destination ADE
22	Destination BL
23	Destination ADE
24	Destination U
25	Destination ADE
26	Destination BL
27	Destination KR
28	Destination KR
31	Auto Sutoff Disable/Enable
33	Rotation ON/OFF
35	No Function
36	No Function
38	Enter G2 Adjustment
41	Re-initialise NVM (Prog 59)
42	Re-initialise geometry (Prog 59)
48	Set NVM as non virgin (Prog 59)
49	Set NVM as virgin (Prog 59)
61	Auto AGC adjustment
63	No Function
64	Enable/disable RGB priority
65	RGB auto-detect enable/disable
66	On timer enable/disable
67	Manual AGC adjustment
68	Enable/disable X26 countermeasure (N problem)
71	Force PAL video (Factory Use Only)
72	Un-force PAL(restore normal video condition)
87	Local keys test
88	No Function
89	Enable/disable watchdog
99	Display Error and Working Time menu





### 5-1. CIRCUIT BOARD LOCATION

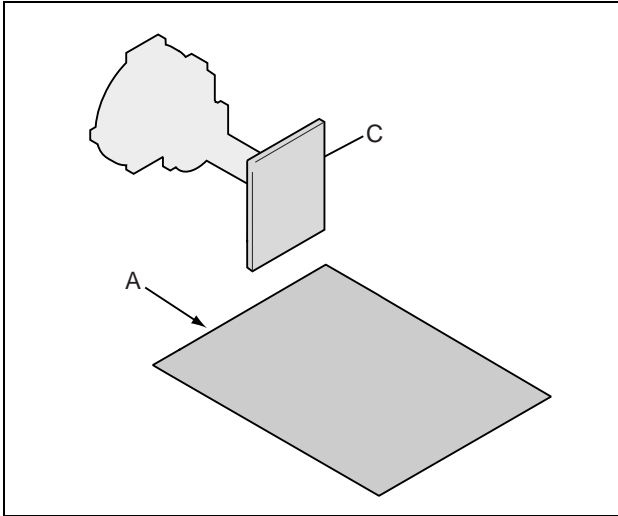









### 5-3. SCHEMATIC DIAGRAMS AND PRINTED WIRING BOARDS

**Note :**

- All capacitors are in  $\mu\text{F}$  unless otherwise noted.
- $\text{pF}$  :  $\mu\mu\text{F}$  50WV or less are not indicated except for electrolytic types.
- Indication of resistance, which does not have one for rating electrical power, is as follows.

Pitch : 5mm  
Electrical power rating : 1/4W

- Chip resistors are 1/10W
- All resistors are in ohms.  
k = 1000 ohms, M = 1000,000 ohms
-  : nonflammable resistor.
-  : fusible resistor.
-  : internal component.
-  : panel designation or adjustment for repair.
- All variable and adjustable resistors have characteristic curve B, unless otherwise noted.
- All voltages are in Volts.
- Readings are taken with a 10Mohm digital mutimeter.
- Readings are taken with a color bar input signal.
- Voltage variations may be noted due to normal production tolerences.
-  : B + bus.
-  : B - bus.
-  : RF signal path.
-  : earth - ground.
-  : earth - chassis.

### Reference Information

RESISTOR	RN	: METAL FILM
	RC	: SOLID
	FPRD	: NON FLAMMABLE CARBON
	FUSE	: NON FLAMMABLE FUSIBLE
	RS	: NON FLAMMABLE METAL OXIDE
	RB	: NON FLAMMABLE CEMENT
	RW	: NON FLAMMABLE WIREWOUND
		: ADJUSTMENT RESISTOR
COIL	LF-8L	: MICRO INDUCTOR
CAPACITOR	TA	: TANTALUM
	PS	: STYROL
	PP	: POLYPROPYLENE
	PT	: MYLAR
	MPS	: METALIZED POLYESTER
	MPP	: METALIZED POLYPROPYLENE
	ALB	: BIPOLAR
	ALT	: HIGH TEMPERATURE
	ALR	: HIGH RIPPLE

**Note :** The components identified by shading and marked  are critical for safety. Replace only with the part numbers specified in the parts list.

**Note :** Les composants identifiés par une trame et par une marque  sont d'une importance critique pour la sécurité. Ne les remplacer que par des pièces de numéro spécifié.

5-2. BLOCK DIAGRAMS (1)

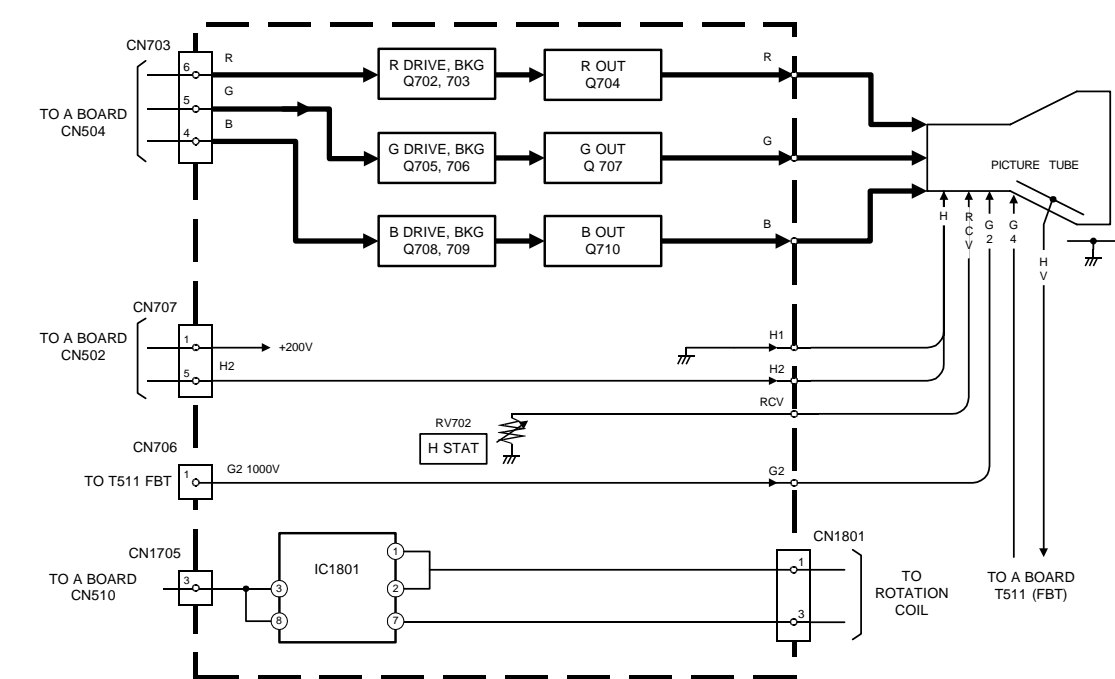
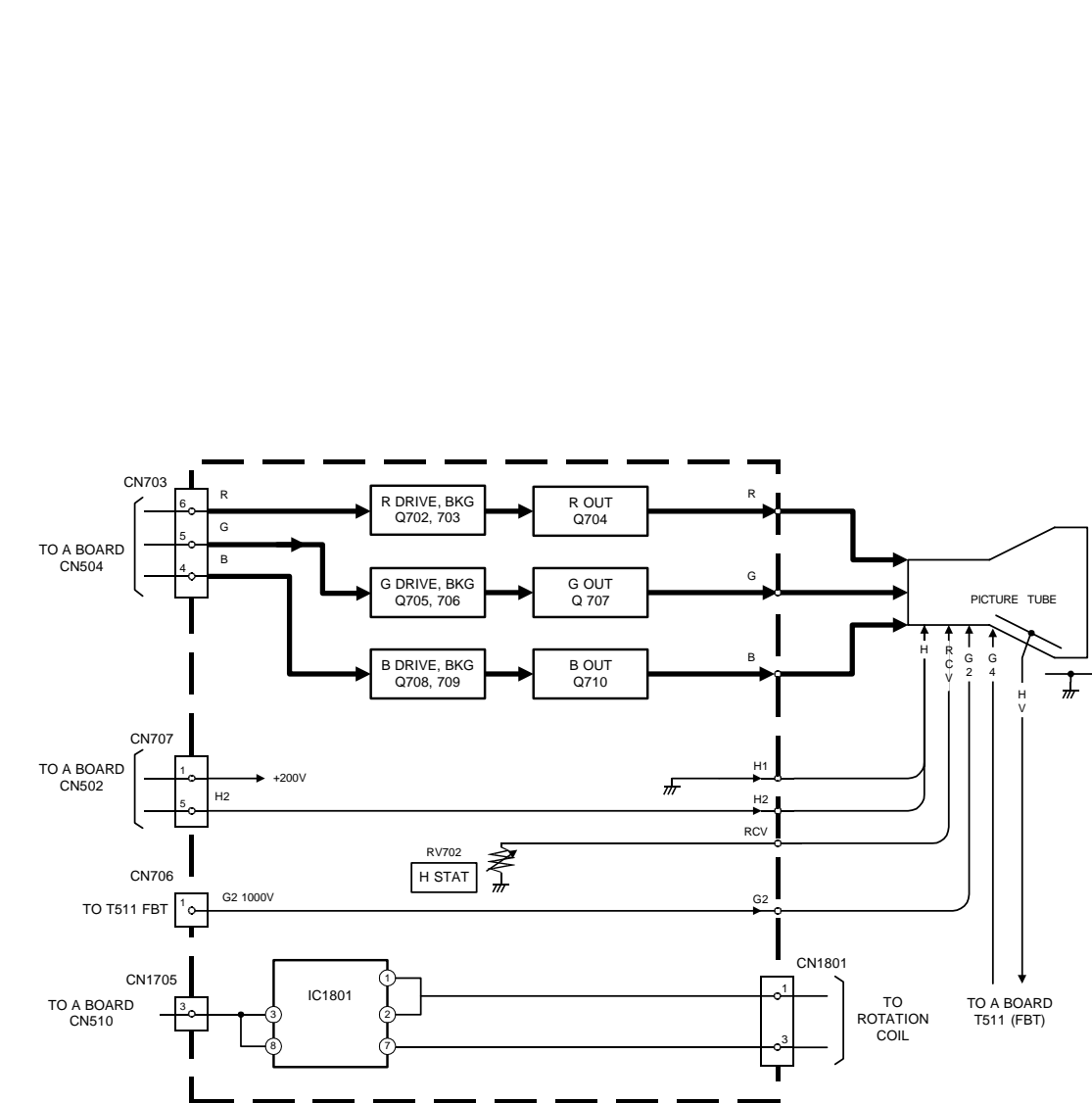
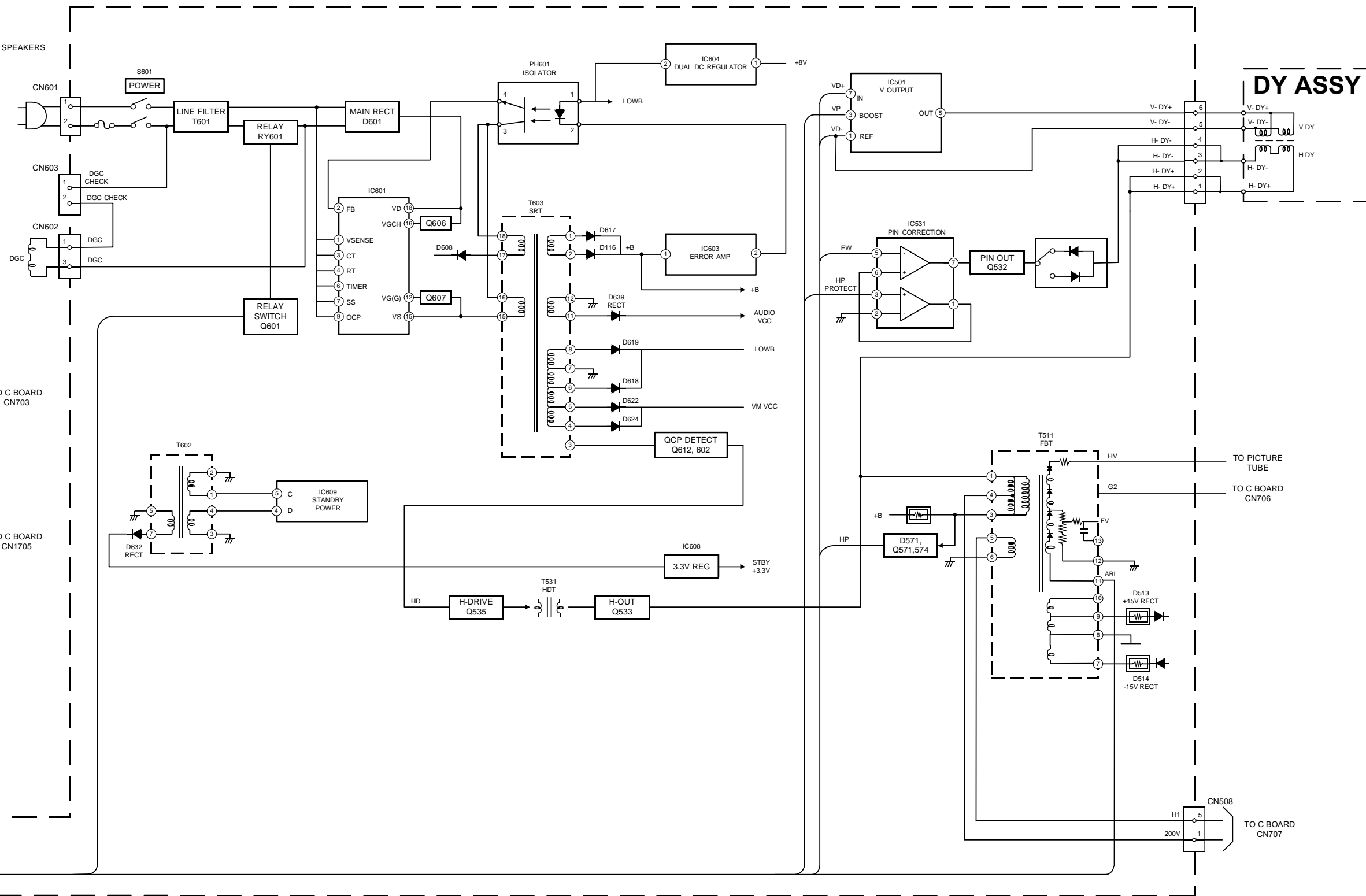
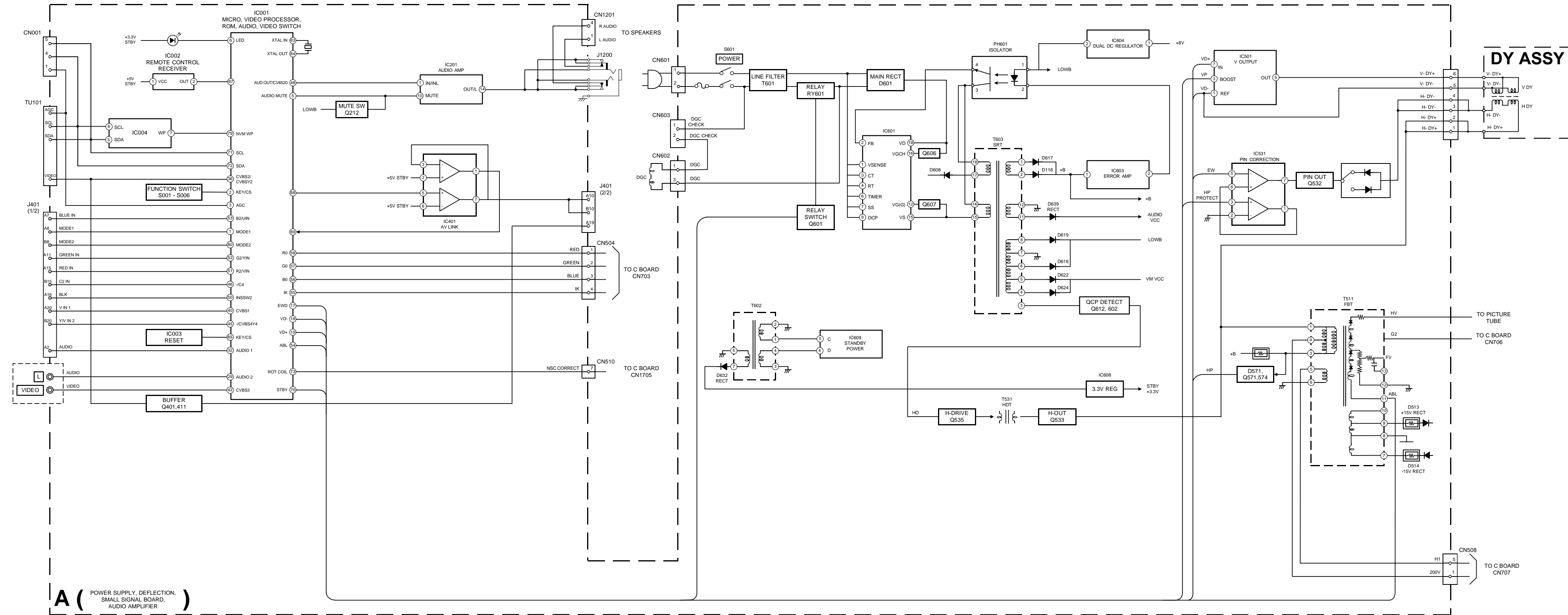



C [R, G, B OUT]

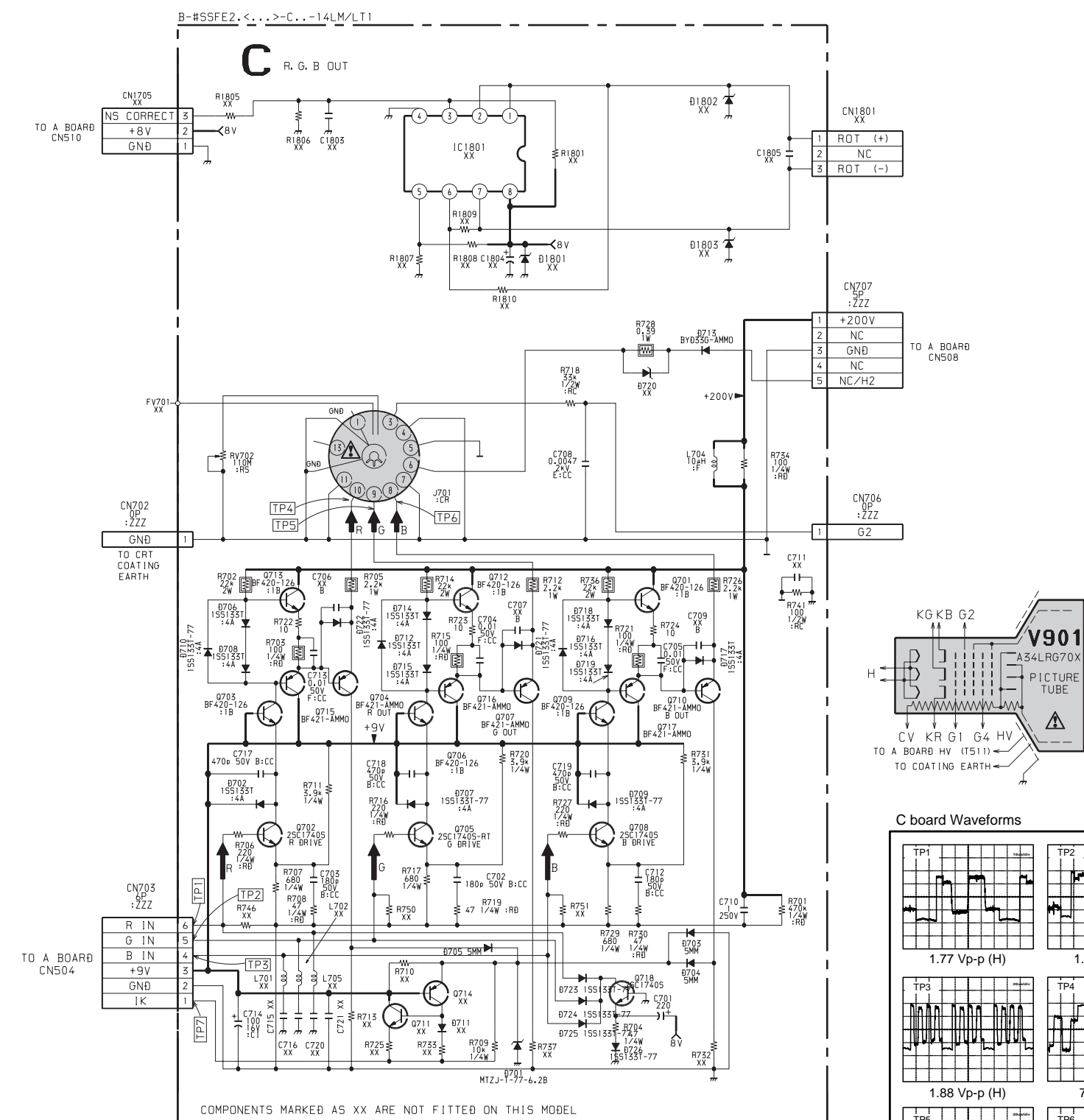

**C board Semiconductor Voltage Table**

Ref	(e)	(b)	(c)	Ref	(e)	(b)	(c)	Ref	(e)	(b)	(c)
Q701	124.2	124.8	202	Q706	7.5	8.1	125.0	Q712	125.8	126.4	201.9
Q702	2.3	3.0	7.5	Q707	124.6	125.8	5.5	Q713	133.0	132.4	201.9
Q703	7.5	8.1	131.6	Q708	3.5	2.1	7.5	Q715	132.3	131.5	8.1
Q704	131	132.4	5.2	Q709	7.5	8.1	123.3	Q716	125.8	125.0	8.1
Q705	2.5	3.1	7.5	Q710	123.0	124.3	5.5	Q717	124.2	123.4	8.1

**C board IC Voltage Table**

Ref No	Pin No	Voltage (V)
IC1801	1	1.3
	2	1.3
	3	1.4
	4	4.1
	5	4.1
	6	7.0
	7	7.0
	8	8.0

[C PRINTED WIRING BOARD]

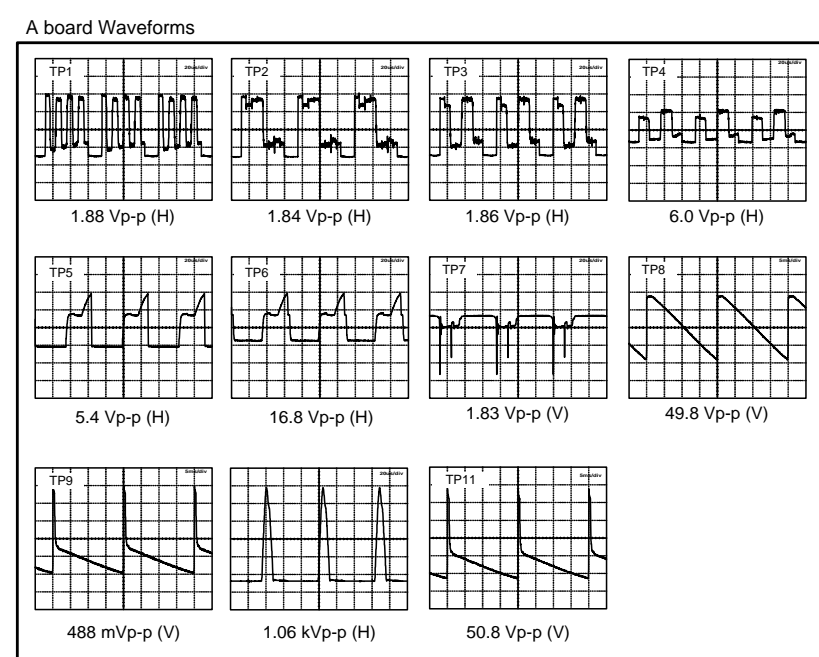
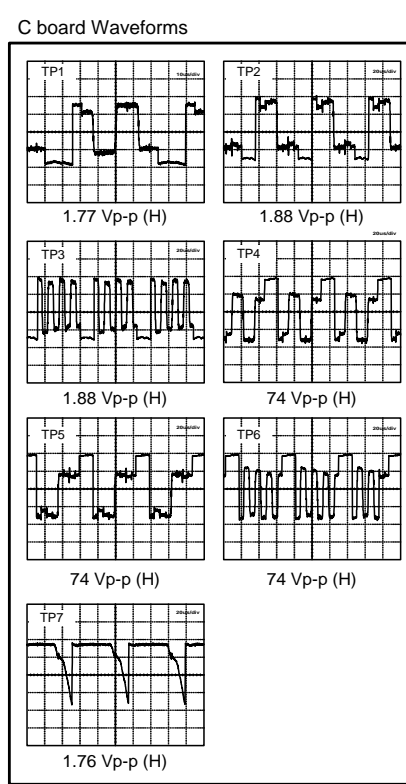
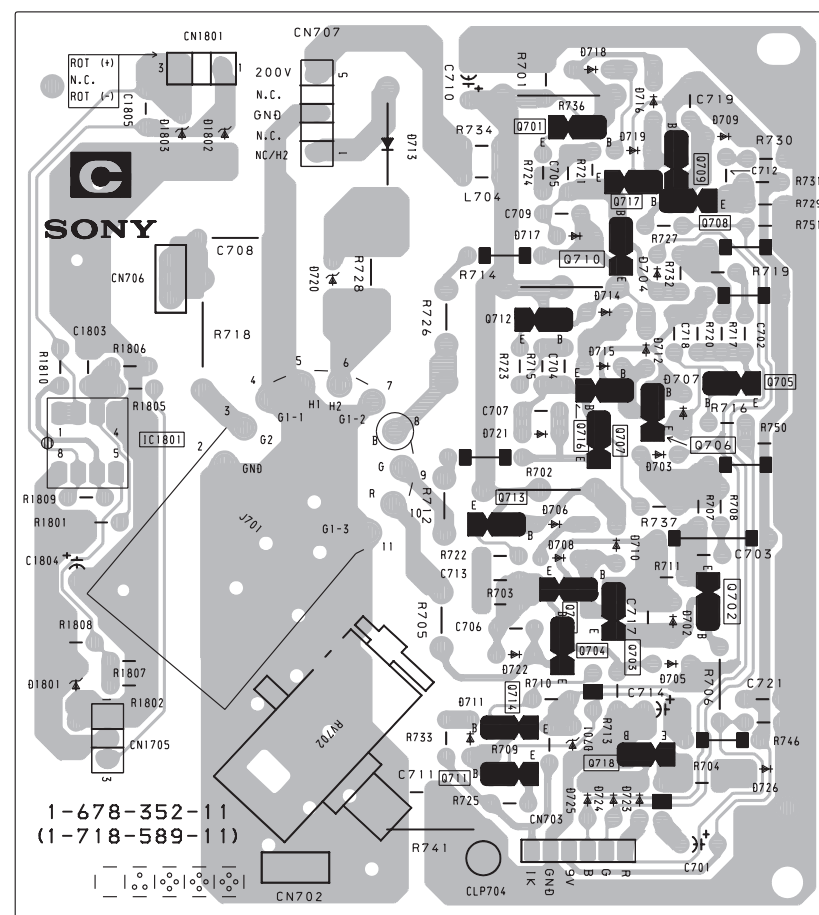

[A PRINTED WIRING BOARD]

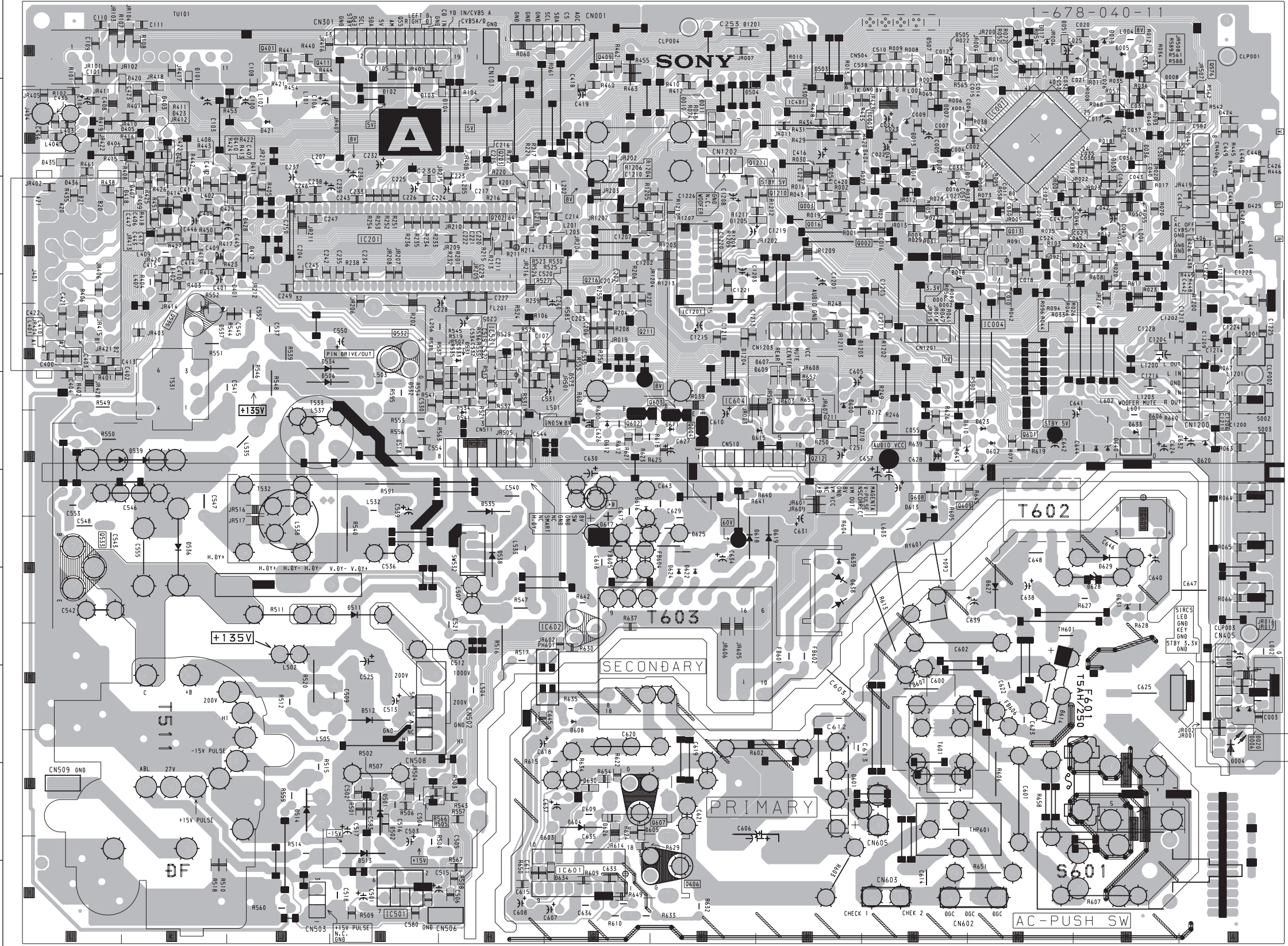

A board IC Voltage Table

Ref No	Pin No	Voltage (V)	Ref No	Pin No	Voltage (V)
IC001	1	0	IC001	67	4.8
	2	3.2		68	0.4
	3	2.9		69	0
	5	0		70	0
	6	2.0		71	0
	8	2.3		72	0
	9	8.0		73	7.1
	10	5.0		74	5.0
	12	0		75	8.1
	13	0		76	-3.5
	14	4.0		77	0
	16	1.4		78	3.2
	17	1.5		79	3.2
	18	0		80	0
	19	0		1	0.3
	20	3.8		3	-12.6
	21	3.8		5	0.2
	22	5.0		6	13.9
26	0	7	0.3		
28	3.5	1	1.4		
29	3.6	2	2.3		
30	1.9	3	1.8		
31	0.3	5	2.4		
32	3.6	6	1.6		
34	1.9	7	6.4		
35	1.4	1	-80.4		
36	3.9	2	-80.5		
38	1.8	3	-80.2		
40	3.3	4	-80.2		
42	3.3	5	-81.5		
43	1.4	6	-81.6		
45	0	7	-77.8		
46	0	9	-81.8		
47	3.6	10	-76		
48	2.8	11	-81.9		
49	2.3	12	-79.4		
50	0.2	14	16.5		
51	2.5	15	11		
52	2.5	16	14.4		
53	2.5	18	86.4		
54	2.1	1	11		
55	5.2	3	4.9		
56	3.0	5	0		
57	3.1	6	0		
58	3.1	7	11.3		
59	3.2	9	0.3		
62	0	10	0		
63	0	12	0		
64	0	14	11.35		
65	0				

A board Semiconductor Voltage Table

Ref	(e)	(b)	(c)	Ref	(e)	(b)	(c)
Q013	0	0.7	0	Q604	0	0	2.5
Q016	0	0	3.3	Q608	0	0	5.6
Q212	0	0.7	0	Q609	5.6	5.6	0
Q401	4.8	4.2	1.8				
Q411	1.1	1.7	4.2	Ref	(s)	(g)	(d)
Q601	5.6	4.8	5.3	Q606	10.9	14.5	86.7
Q602	14.2	5.1	8	Q607	-82.4	-79.9	10.9
Q603	8	8	0	Q635	0	2.5	95.2

A board Location Table

DIODE				IC				TRANSISTOR			
D001	J-2	D435	A-2	D634	F-10	IC001	K-2	Q013	K-3	Q016	I-3
D002	J-4	D436	A-3	D639	I-6	IC002	M-8	D102	I-5	Q212	I-5
D003	J-2	D501	D-9	D640	L-5	IC003	I-2	D103	E-2	Q401	C-1
D004	M-8	D502	D-9	D1201	H-1	IC004	K-4	D104	E-2	Q411	D-1
D006	M-8	D503	I-1	D1203	H-4	IC005	I-2	D105	I-5	Q532	G-5
D007	J-2	D504	H-2	D1204	H-4	IC006	F-10	D106	I-5	Q533	A-6
D008	L-1	D505	J-1			IC007	F-10	D107	L-1	Q535	B-4
D008	L-1	D506	D-5			IC008	F-5	D108	G-2	Q601	K-5
D010	G-2	D507	J-1			IC009	L-6	D109	L-1	Q602	G-5
D011	H-2	D512	D-8			IC010	L-6	D110	B-2	Q603	G-5
D012	J-2	D513	D-9			IC011	H-4	D111	B-2	Q604	G-5
D013	M-8	D514	C-9			IC012	H-4	D112	I-5	Q605	G-10
D014	M-8	D514	D-4			IC013	H-4	D113	I-5	Q606	G-5
D016	J-2	D535	E-6			IC014	H-4	D114	B-3	Q607	G-9
D017	L-1	D536	B-6			IC015	H-4	D115	B-3	Q608	J-6
D018	G-2	D537	C-4			IC016	H-4	D116	B-1	Q609	J-6
D019	L-1	D538	F-6								
D020	M-8	D539	B-5								
D035	L-2	D573	F-5								
D036	L-2	D601	I-9								
D051	K-1	D602	K-5								
D101	B-1	D604	F-9								
D103	E-2	D610	J-5								
D104	E-2	D611	G-5								
D105	I-5	D612	G-5								
D106	I-5	D613	K-8								
D107	I-5	D614	J-6								
D108	I-5	D614	K-8								
D109	I-5	D616	H-5								
D110	I-5	D616	G-6								
D111	I-5	D617	G-6								
D112	I-5	D618	H-6								
D113	I-5	D620	M-5								
D114	B-3	D621	J-5								
D115	B-3	D623	J-5								
D120	B-1	D627	K-7								
D121	C-2	D631	L-6								
D123	B-2	D632	L-5								
D124	M-2	D633	L-5								

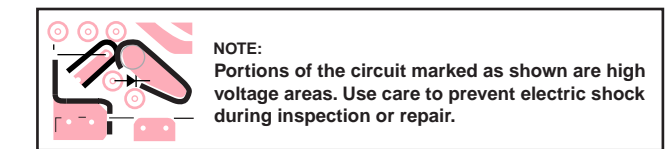



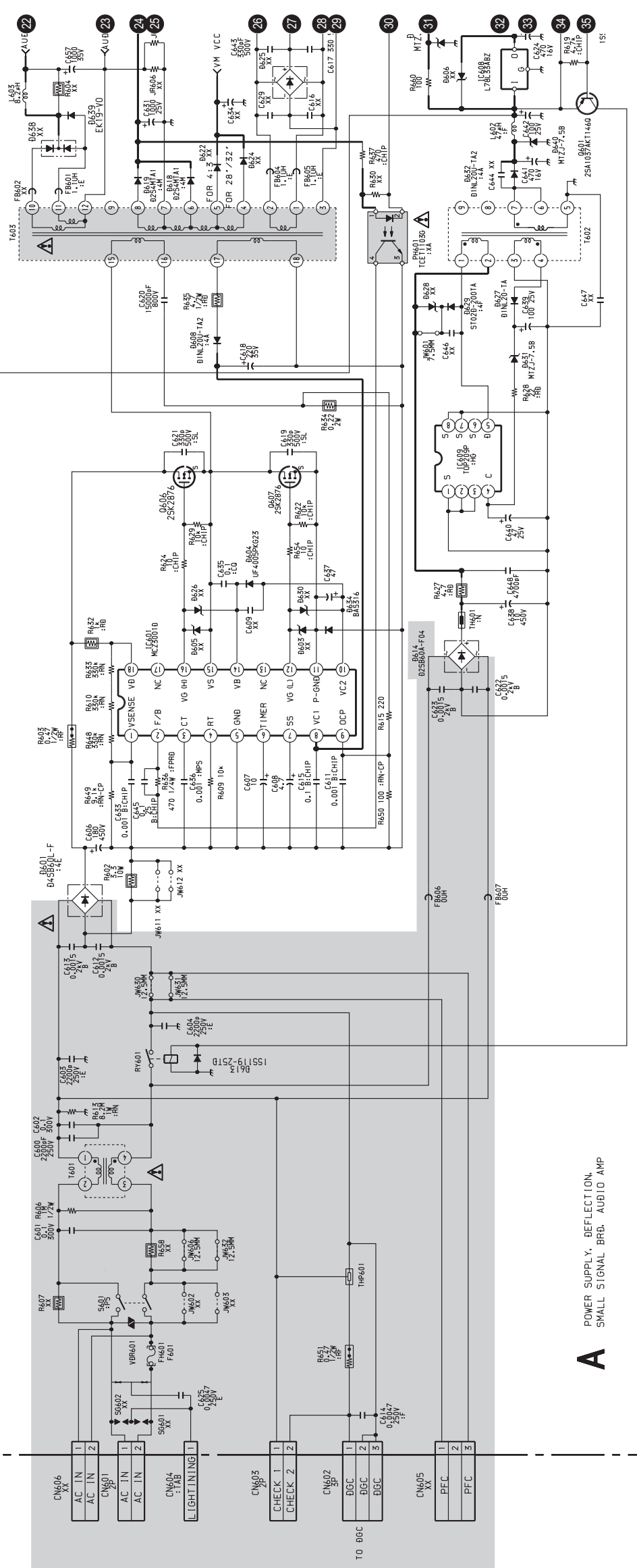
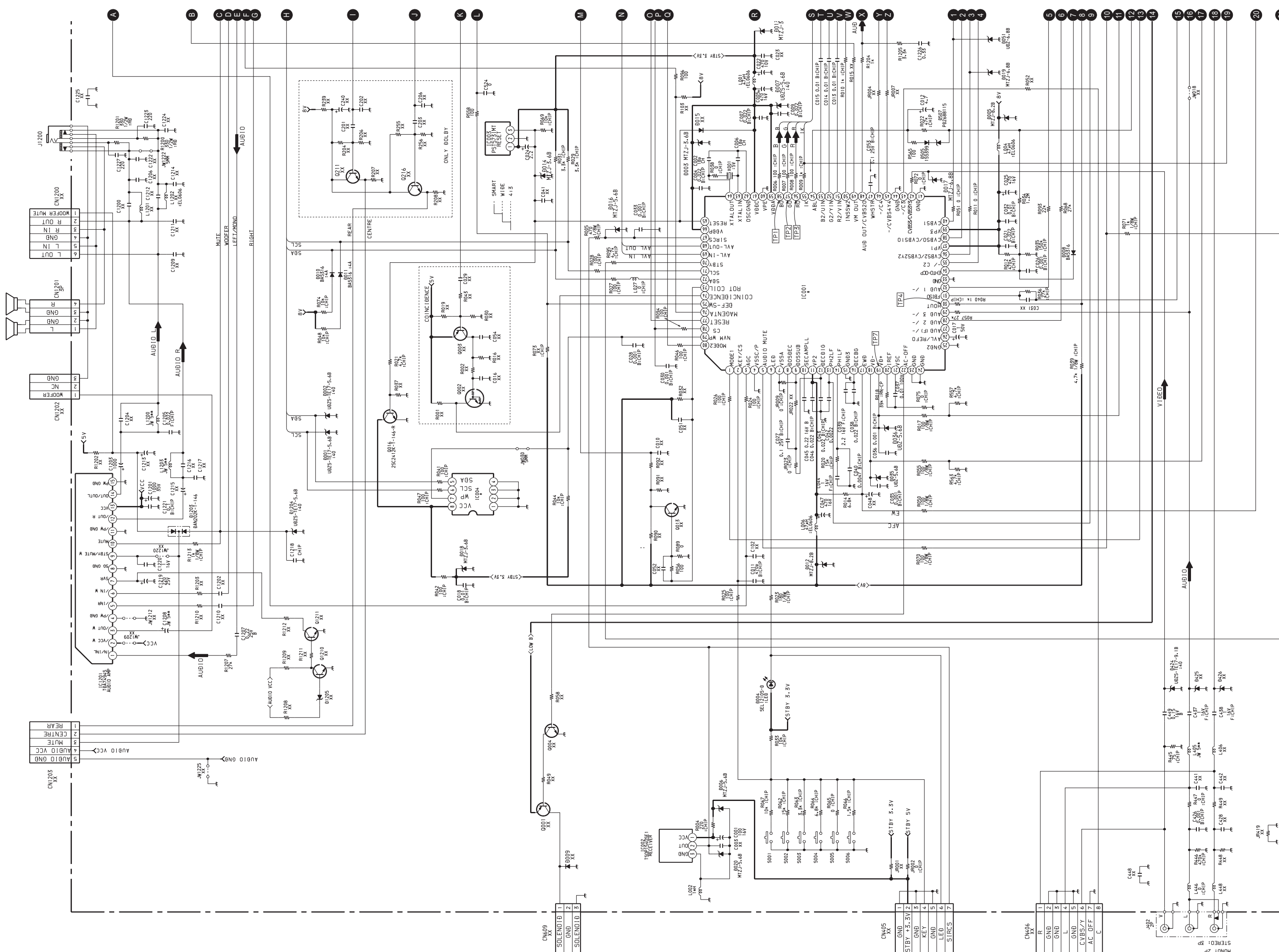

**A** POWER SUPPLY, REFLECTION, SMALL SIGNAL BRD, AUDIO AMP

COMPONENTS MARKED AS 'XX' ARE NOT FITTED ON THIS MODEL

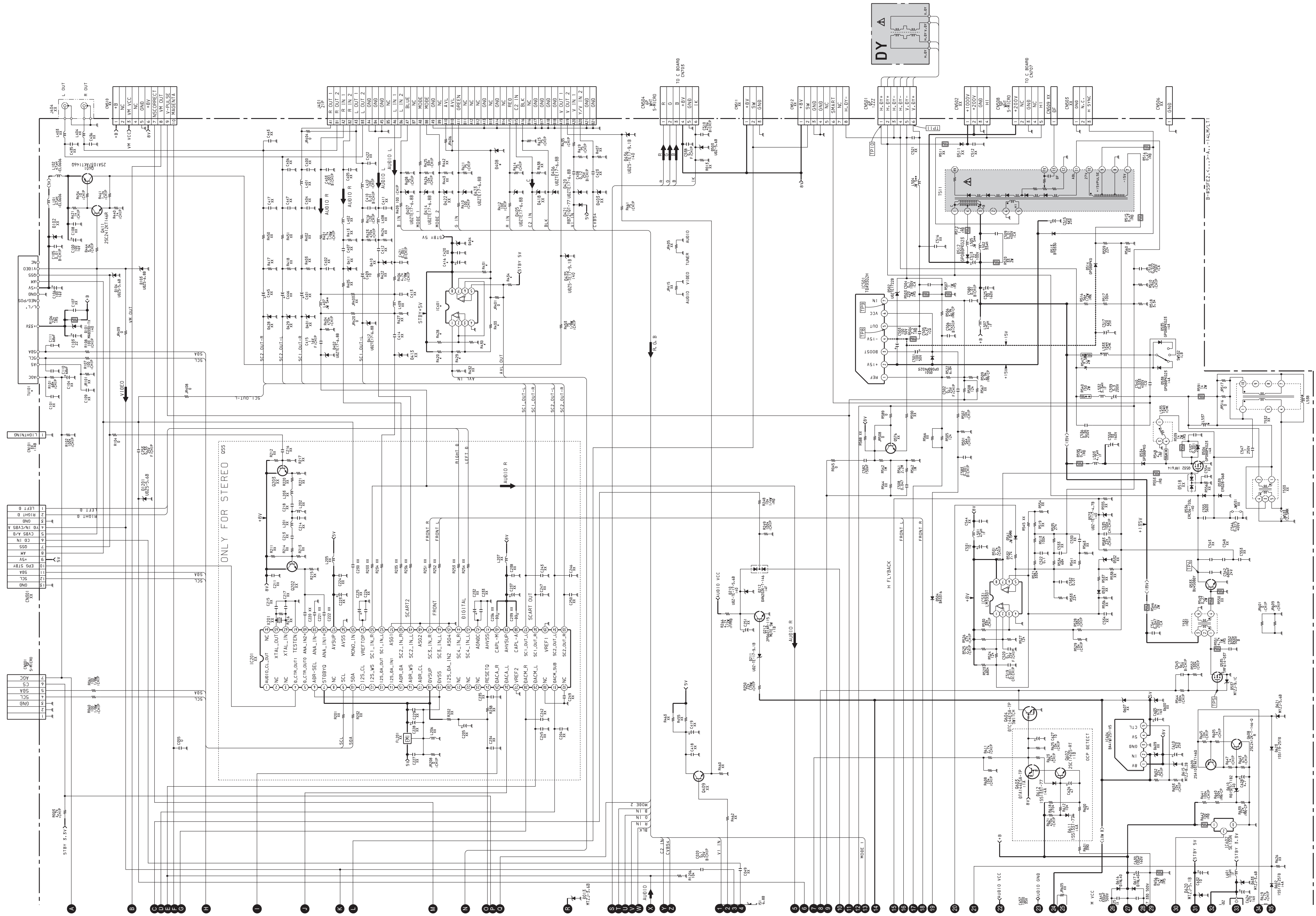

## 5-4. SEMICONDUCTORS

LM393DT  
TDA2822M  
TEA2124

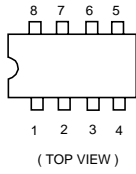

SE-135N  
SE135N-LF12

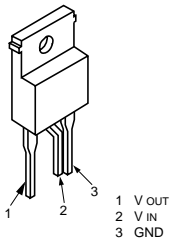

TDA9392H

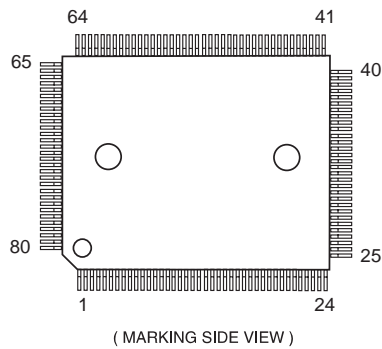

TOP209P

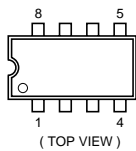

BF421-AMMO  
2SA1091-O

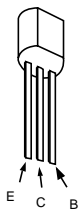

DTA144ESA  
DTA144ESA-TP  
DTC114EKA  
DTC114EKA-T146  
DTC143TKA-T146  
DTC144EKA-T-146R  
2SA1037K-T-146-R  
R2SA1162-G  
2SA1037K-T-146-QR  
2SD601A-QTX  
2SC1623-L5-L6  
2SC2412K-QR  
2SC2412K-T-146-R

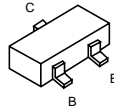

IRF614-LF

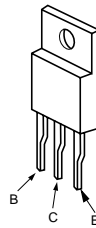

2SA933AS-QRT  
2SAG33ASQT  
2SA933AS-RT  
2SC1740S-RT

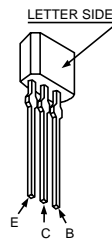

2SK2251-01-F19

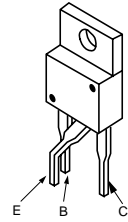

AK04-V1	ERD28-06S
AU-01Z-V1	ERC06-15SL
BYD33G	FMN-G12S
BYD33G-	GP08DPKG23
AMMO	RG1CLF-B1
DINL20-U-TA2	RGP10GPKG23
DINL40-U-TR2	RU-3AM
ERB44-06TP1	RU3YX-LF-C4
EGP20G	RU3YX-V1
EG-1Z-V1	RU-4AM-T3
EL1Z	1SS292T-77
ERD28-06S	

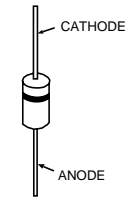

DAN202K  
DAN202K-T146

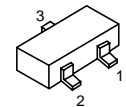

D4SB60L-F

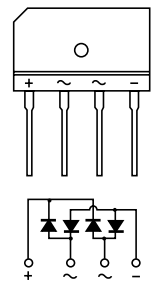

2SC2785-HFE

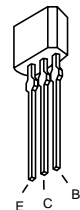

ERA81-004TP1	MTZJ-T-77-15B
ERA83-006	MTZJ-T-77-33A
MTZJ-3.6A	MTZJ-33C
MTZJ-T-77-2.2A	MTZJ-7.5B
HZS9.INBZ	RD3.9ES-B2
MTZJ-T-77-3.6B	RD5.6ESB2
MTZJ-T-77-5.6B	RD6.8ES-B2
MTZJ-T-77-5.6C	RD7.5ESB2
MTZJ-T-77-6.8A	RD9.1ES-B3
MTZJ-T-77-6.8C	RD10ESB2
MTZJ-T-77-8.2B	RD15ESB2
MTZJ-T-77-7.5B	1SS119-25TD
MTZJ-T-77-9.1A	1SS133T-77
MTZJ-T-77-9.1C	
MTZJ-T-77-10	

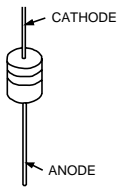

SLA-570KT3F

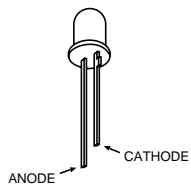

1SS355TE-17  
 RD12SB2  
 UDZS-TE-17-4.7B  
 UDZS-TE-17-5.6B  
 UDZS-TE-17-6.8B  
 UDZS-TE-17-9.1B  
 UDZ-TE-17-22B

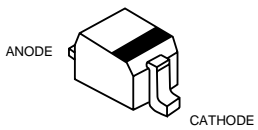

UF4005PKG23

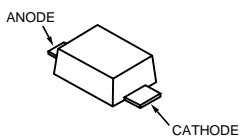



## 5-5 IC BLOCK DIAGRAMS

**A BOARD IC604 BA41W12ST**

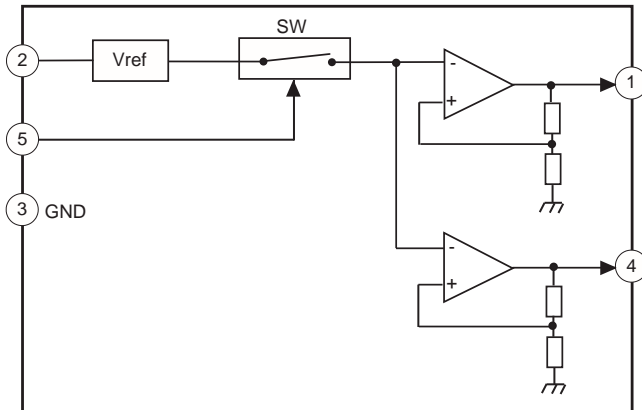

**A BOARD IC401/IC531 LM393TD**

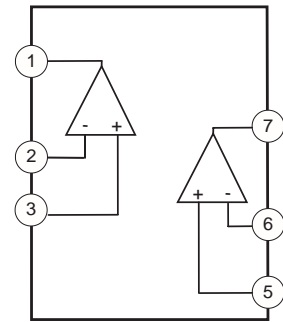

**A BOARD IC601 MCZ3001D**

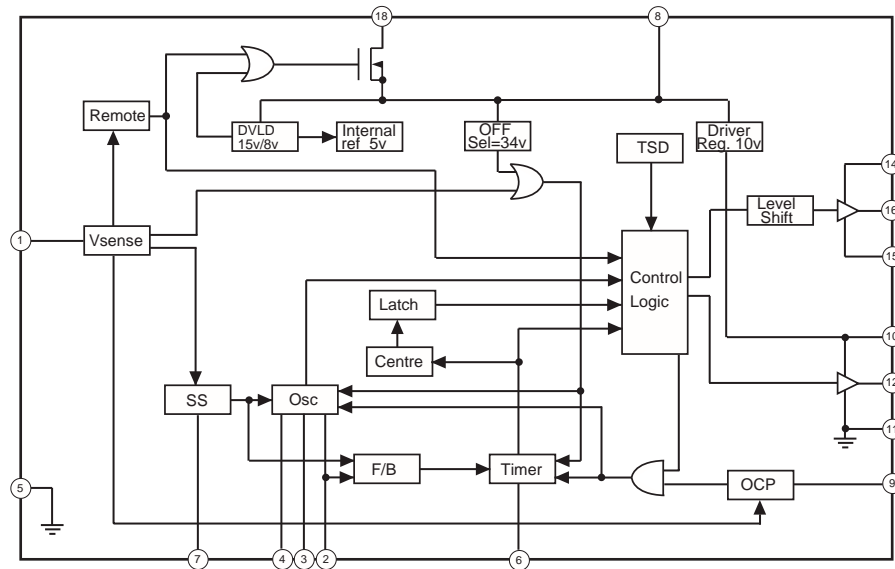

**A BOARD IC1201 TDA7494**

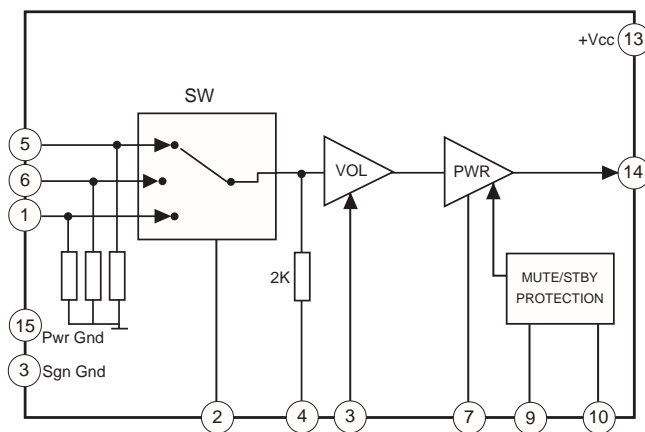

## SECTION 6 EXPLODED VIEWS

**Note :** Les composants identifiés par une trame et par une marque  $\Delta$  sont d'une importance critique pour la sécurité. Ne les remplacer que par des pièces du numéro spécifié.

**Note :** The components identified by shading and marked  $\Delta$  are critical for safety. Replace only with the part numbers specified in the parts list.

**NOTE :**

- Items with no part number and no description are not stocked because they are seldom required for routine service.
- The construction parts of an assembled part are indicated with a collation number in the remarks column.
- Items marked “\*” are not stocked since they are seldom required for routine service. Some delay should be anticipated when ordering these items.

### 6-1. CHASSIS

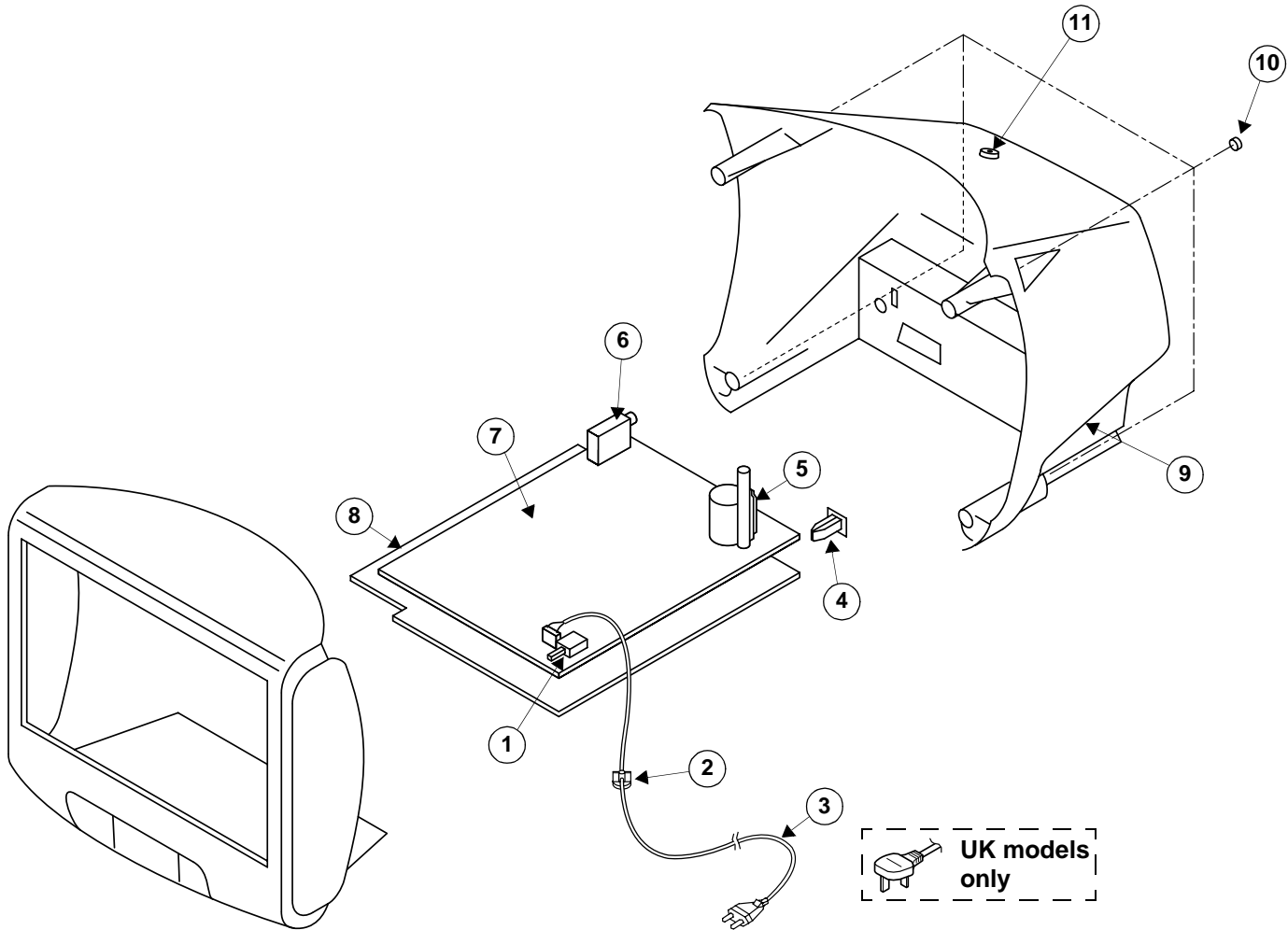

REF.NO.	PART.NO	DESCRIPTION	REMARK	REF.NO.	PART.NO	DESCRIPTION	REMARK
1	$\Delta$ 1-571-433-21	SWITCH, PUSH (AC POWER)		7	*A-1632-901-A	A BOARD, COMPLETE (KV-14LM1B)	
2	*4-202-531-01	AC CORD LOCK (SC)			*A-1632-891-A	A BOARD, COMPLETE (KV-14LM1E)	
3	$\Delta$ 1-765-286-11	CORD, POWER (KV-14LM1B/14LM1E/14LM1K KV-14LT1B/14LT1E/14LT1K)			*A-1632-902-A	A BOARD, COMPLETE (KV-14LM1K)	
	$\Delta$ 1-776-860-11	POWER CORD, FILTER (KV-14LM1B/14LT1B/ KV-14LM1U/14LT1U)			*A-1632-903-A	A BOARD, COMPLETE (KV-14LM1U)	
4	*4-204-517-02	SUPPORT, FBT (KV-14LM1/14LT1B/14LT1E)			*A-1632-895-A	A BOARD, COMPLETE (KV-14LT1B)	
	*4-204-517-01	SUPPORT, FBT (KV-14LT1K/14LT1U)			*A-1632-886-A	A BOARD, COMPLETE (KV-14LT1E)	
5	$\Delta$ 1-453-347-11	TRANSFORMER ASSY, FLYBACK (NX-1747//U2A4)			*A-1632-896-A	A BOARD, COMPLETE (KV-14LT1K)	
6	8-598-535-00	FRONTEND BTF-EF411 (KV-14LM1B/14LT1B)			*A-1632-897-A	A BOARD, COMPLETE (KV-14LT1U)	
	8-598-531-00	FRONTEND BTF-EC401 (KV-14LM1E/14LT1E)		8	*4-204-143-02	BRACKET, MAIN	
	8-598-537-00	FRONTEND BTF-EP401 (KV-14LM1K/14LT1K)		9	4-205-378-11	REAR COVER (KV-14LM1)	
	8-598-527-00	FRONTEND BTF-EU601 (KV-14LM1U/14LT1U)			4-205-378-01	REAR COVER (KV-14LT1)	
				10	7-685-663-79	SCREW +BVTP 4X16 TYPE 2 IT-3	
				11	4-203-090-01	TERMINAL ANTENNA	

## 6-2. PICTURE TUBE

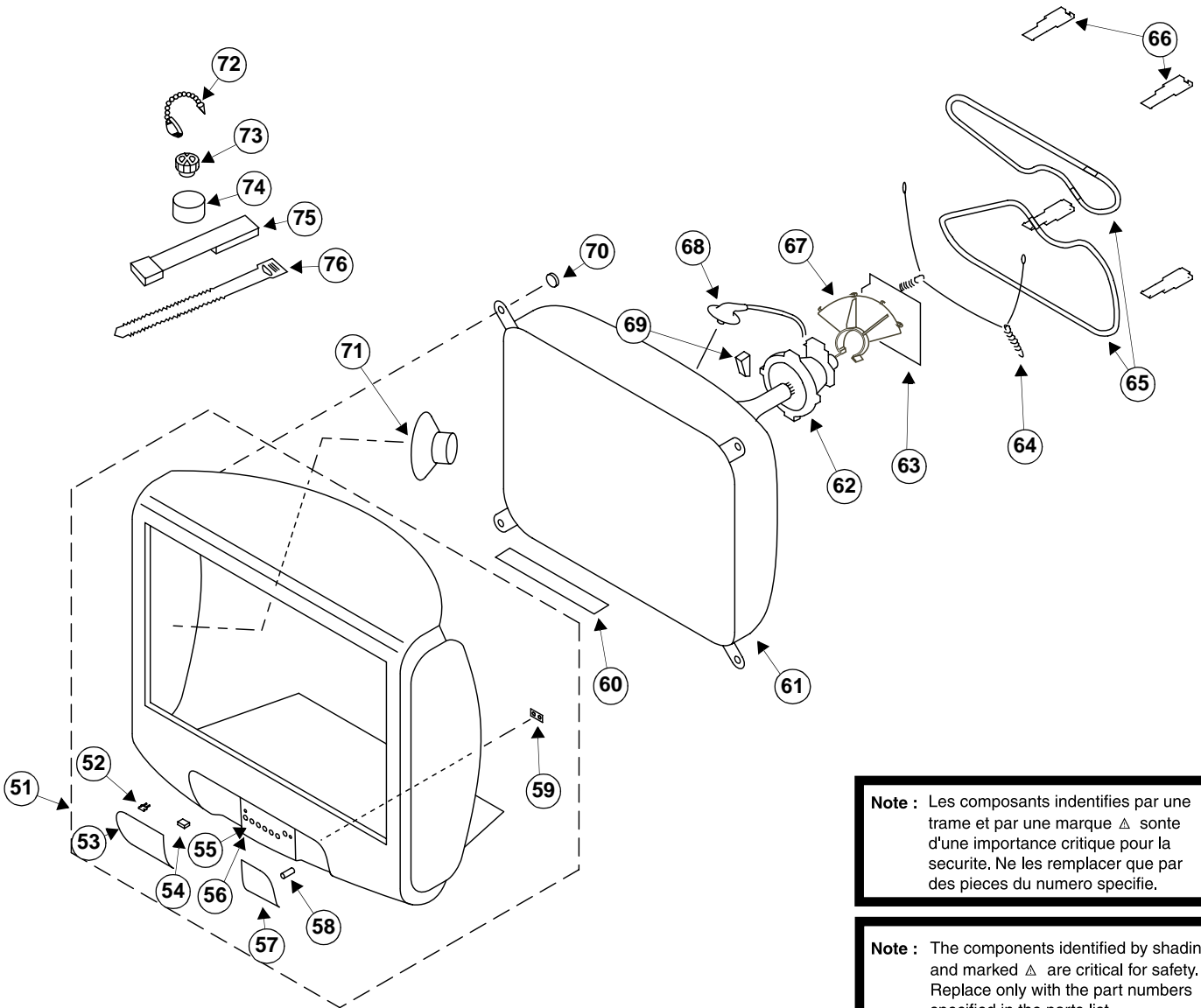

**Note :** Les composants identifiés par une trame et par une marque  $\Delta$  sont d'une importance critique pour la sécurité. Ne les remplacer que par des pièces du numéro spécifié.

**Note :** The components identified by shading and marked  $\Delta$  are critical for safety. Replace only with the part numbers specified in the parts list.

REF.NO.	PART.NO	DESCRIPTION	REMARK	REF.NO.	PART.NO	DESCRIPTION	REMARK
51	X-4200-589-1	BEZNET ASSY (KV-14LM1)	52, 55-59	63	*A-1632-885-A	C BOARD, COMPLETE	
	X-4200-588-1	BEZNET ASSY (KV-14LT1)	52-59	64	4-369-318-21	SPRING, TENSION	
52	4-047-464-01	CATCHER, PUSH		65	$\Delta$ 1-419-548-11	COIL, DEGAUSSING	
53	4-205-372-01	DOOR CONTROL (KV-14LT1)		66	*4-205-377-01	DGC HOLDER	
54	4-205-373-01	SHAFT DOOR (KV-14LT1)		67	*4-203-097-01	HOLDER, HV	
55	4-205-376-01	MULTI BUTTON		68	$\Delta$ 1-540-007-13	CAP ASSY, HIGH VOLTAGE	
56	4-205-550-01	COVER MULTI BUTTON		69	4-074-601-01	SPACER, DY	
57	4-205-380-01	BUTTON, POWER (KV-14LM1)		70	4-365-808-01	SCREW (5), TAPPING	
	4-205-374-01	BUTTON, POWER (KV-14LT1)		71	1-529-711-11	SPEAKER, (8CM)	
58	4-204-426-01	SPRING		72	4-308-870-00	CLIP, LEAD WIRE	
59	4-205-375-01	GUIDE, LIGHT		73	1-452-094-00	MAGNET, ROTATABLE DISK; 15MM $\emptyset$	
60	4-203-128-01	SHEET, BLOTTING		74	1-425-032-00	MAGNET, DISK; 10MM $\emptyset$	
61	$\Delta$ 8-735-570-05	PICTURE TUBE (A34LRG70X)		75	X-4387-214-1	PERMALLOY ASSY, CORRECTION	
62	$\Delta$ 8-451-401-21	DEFLECTION YOKE (Y14RSA-L)		76	3-701-007-00	BAND, BINDING	

# SECTION 7 ELECTRICAL PARTS LIST

## PARTS LISTING TABLE OF CONTENTS

	<u>Page</u>
<b>C BOARD COMPLETE Parts List :</b> .....	43
<b>A BOARD COMMON Parts List :</b> Parts common to all models listed in this manual .....	44
<b>A BOARD VARIANT Parts List :</b> Parts that belong only to the model specified	
<u>Model</u>	
KV-14LM1 .....	50
KV-14LT1 .....	50
<b>MISCELLANEOUS :</b> .....	51
<b>ACCESSORIES AND PACKAGING MATERIALS :</b> .....	51

**Note :** Refer to the designated variant parts list when seeking a part indicated by an asterisk (\*)  
 Parts indicated (**XX**) on the Schematic Diagram are not used in this model and therefore do not appear in the Parts List.

The components identified by shading and marked  $\Delta$  are critical for safety. Replace only with the part number specified.

C

REF. NO.	PART.NO	DESCRIPTION	REMARK	REF. NO.	PART.NO	DESCRIPTION	REMARK
<b>*A-1632-885-A C Board, Complete</b>				D726	8-719-991-33	DIODE 1SS133T-77	
< CAPACITOR >				< SOCKET >			
C701	1-126-934-11	ELECT	220UF 20.00% 16V	J701	$\Delta$ 1-251-595-11	SOCKET, CRT	
C702	1-102-109-00	CERAMIC	180PF 10.00% 50V	< COIL >			
C703	1-102-109-00	CERAMIC	180PF 10.00% 50V	L704	1-414-183-41	INDUCTOR 10UH	
C704	1-101-004-00	CERAMIC	0.01UF 50V	< TRANSISTOR >			
C705	1-101-004-00	CERAMIC	0.01UF 50V	Q701	8-729-046-28	TRANSISTOR BF420-126	
C708	1-162-114-00	CERAMIC	0.0047UF 2KV	Q702	8-729-119-78	TRANSISTOR 2SC1740S-RT	
C710	1-107-957-11	ELECT	1UF 20.00% 250V	Q703	8-729-046-28	TRANSISTOR BF420-126	
C712	1-102-109-00	CERAMIC	180PF 10.00% 50V	Q704	8-729-200-17	TRANSISTOR BF421-AMMO	
C713	1-101-004-00	CERAMIC	0.01UF 50V	Q705	8-729-119-78	TRANSISTOR 2SC1740S-RT	
C714	1-104-665-11	ELECT	100UF 20.00% 16V	Q706	8-729-046-28	TRANSISTOR BF420-126	
C717	1-102-114-00	CERAMIC	470PF 10.00% 50V	Q707	8-729-200-17	TRANSISTOR BF421-AMMO	
C718	1-102-114-00	CERAMIC	470PF 10.00% 50V	Q708	8-729-119-78	TRANSISTOR 2SC1740S-RT	
C719	1-102-114-00	CERAMIC	470PF 10.00% 50V	Q709	8-729-046-28	TRANSISTOR BF420-126	
< CONNECTOR >				Q710	8-729-200-17	TRANSISTOR BF421-AMMO	
CN702	1-695-915-11	TAB (CONTACT)		Q712	8-729-046-28	TRANSISTOR BF420-126	
CN703	*1-564-509-11	PLUG, CONNECTOR 6P		Q713	8-729-046-28	TRANSISTOR BF420-126	
CN706	1-695-915-11	TAB (CONTACT)		Q715	8-729-200-17	TRANSISTOR BF421-AMMO	
CN707	*1-564-508-11	PLUG, CONNECTOR 5P		Q716	8-729-200-17	TRANSISTOR BF421-AMMO	
< DIODE >				Q717	8-729-200-17	TRANSISTOR BF421-AMMO	
D701	8-719-109-93	DIODE MTZJ-T-77-6.2B		Q718	8-729-119-78	TRANSISTOR 2SC1740S-RT	
D702	8-719-991-33	DIODE 1SS133T-77		< RESISTOR >			
D703	1-535-303-00	LEAD, JUMPER (5.0MM)		R701	1-247-895-91	CARBON 470K 5% 1/4W	
D704	1-535-303-00	LEAD, JUMPER (5.0MM)		R702	1-215-900-11	METAL OXIDE 22K 5% 2W	
D705	1-535-303-00	LEAD, JUMPER (5.0MM)		R703	1-249-405-11	CARBON 100 5% 1/4W	
D706	8-719-991-33	DIODE 1SS133T-77		R704	1-249-401-11	CARBON 47 5% 1/4W	
D707	8-719-991-33	DIODE 1SS133T-77		R705	1-215-871-11	METAL OXIDE 2.2K 5% 1W	
D708	8-719-991-33	DIODE 1SS133T-77		R706	1-247-815-91	CARBON 220 5% 1/4W	
D709	8-719-991-33	DIODE 1SS133T-77		R707	1-247-827-91	CARBON 680 5% 1/4W	
D710	8-719-991-33	DIODE 1SS133T-77		R708	1-249-401-11	CARBON 47 5% 1/4W	
D712	8-719-991-33	DIODE 1SS133T-77		R709	1-249-429-11	CARBON 10K 5% 1/4W	
D713	8-719-950-57	DIODE BYD33G-AMMO		R711	1-247-845-91	CARBON 3.9K 5% 1/4W	
D714	8-719-991-33	DIODE 1SS133T-77		R712	1-215-871-11	METAL OXIDE 2.2K 5% 1W	
D715	8-719-991-33	DIODE 1SS133T-77		R714	1-215-900-11	METAL OXIDE 22K 5% 2W	
D716	8-719-991-33	DIODE 1SS133T-77		R715	1-249-405-11	CARBON 100 5% 1/4W	
D717	8-719-991-33	DIODE 1SS133T-77		R716	1-247-815-91	CARBON 220 5% 1/4W	
D718	8-719-991-33	DIODE 1SS133T-77		R717	1-247-827-91	CARBON 680 5% 1/4W	
D719	8-719-991-33	DIODE 1SS133T-77		R718	1-202-814-11	SOLID 33K 10% 1/2W	
D721	8-719-991-33	DIODE 1SS133T-77		R719	1-249-401-11	CARBON 47 5% 1/4W	
D722	8-719-991-33	DIODE 1SS133T-77		R720	1-247-845-91	CARBON 3.9K 5% 1/4W	
D723	8-719-991-33	DIODE 1SS133T-77		R721	1-249-405-11	CARBON 100 5% 1/4W	
D724	8-719-991-33	DIODE 1SS133T-77					
D725	8-719-991-33	DIODE 1SS133T-77					



REF.NO.	PART.NO	DESCRIPTION	REMARK
R722	1-249-393-11	CARBON 10 5% 1/4W	
R723	1-249-393-11	CARBON 10 5% 1/4W	
R724	1-249-393-11	CARBON 10 5% 1/4W	
R726	1-215-871-11	METAL OXIDE 2.2K 5% 1W	
R727	1-247-815-91	CARBON 220 5% 1/4W	
R728	1-216-344-00	METAL OXIDE 0.39 5% 1W	
R729	1-247-827-91	CARBON 680 5% 1/4W	
R730	1-249-401-11	CARBON 47 5% 1/4W	
R731	1-247-845-91	CARBON 3.9K 5% 1/4W	
R734	1-247-807-31	CARBON 100 5% 1/4W	
R736	1-215-900-11	METAL OXIDE 22K 5% 2W	
R741	1-202-549-00	SOLID 100 20% 1/2W	

< VARIABLE RESISTOR >

RV702 1-241-656-21 RES, ADJ, METAL FILM 110M

**\*A-1632-901-A A Board, Complete (KV-14LM1B)**  
**\*A-1632-891-A A Board, Complete (KV-14LM1E)**  
**\*A-1632-902-A A Board, Complete (KV-14LM1K)**  
**\*A-1632-903-A A Board, Complete (KV-14LM1U)**  
**\*A-1632-895-A A Board, Complete (KV-14LT1B)**  
**\*A-1632-886-A A Board, Complete (KV-14LT1E)**  
**\*A-1632-896-A A Board, Complete (KV-14LT1K)**  
**\*A-1632-897-A A Board, Complete (KV-14LT1U)**

**A Board, Common Parts**

4-203-258-01 HOLDER, LED  
 \*4-374-846-01 COVER, CAPACITOR, CAP TYPE  
 4-382-854-01 SCREW (M3X8), P, SW (+)  
 4-382-854-11 SCREW (M3X10), P, SW (+)

< CAPACITOR >

C001	1-126-933-11	ELECT 100UF	20.00% 16V
C002	1-163-233-11	CERAMIC CHIP 18PF	5.00% 50V
C004	1-163-037-11	CERAMIC CHIP 0.022UF	10.00% 50V
C005	1-126-935-11	ELECT 470UF	20.00% 16V
C006	1-163-233-11	CERAMIC CHIP 18PF	5.00% 50V
C007	1-163-037-11	CERAMIC CHIP 0.022UF	10.00% 50V
C009	1-163-037-11	CERAMIC CHIP 0.022UF	10.00% 50V
C011	1-163-005-11	CERAMIC CHIP 470PF	10.00% 50V
C012	1-126-963-11	ELECT 4.7UF	20.00% 50V
C013	1-163-021-91	CERAMIC CHIP 0.01UF	10.00% 50V
C014	1-163-021-91	CERAMIC CHIP 0.01UF	10.00% 50V
C015	1-163-021-91	CERAMIC CHIP 0.01UF	10.00% 50V
C017	1-126-960-11	ELECT 1UF	20.00% 50V
C018	1-163-021-91	CERAMIC CHIP 0.01UF	10.00% 50V
C020	1-164-004-11	CERAMIC CHIP 0.1UF	10.00% 25V
C021	1-163-037-11	CERAMIC CHIP 0.022UF	10.00% 50V

REF.NO.	PART.NO	DESCRIPTION	REMARK
C022	1-126-925-11	ELECT 470UF	20.00% 10V
C024	1-126-961-11	ELECT 2.2UF	20.00% 50V
C025	1-126-935-11	ELECT 470UF	20.00% 16V
C026	1-163-009-11	CERAMIC CHIP 0.001UF	10.00% 50V
C027	1-164-004-11	CERAMIC CHIP 0.1UF	10.00% 25V
C028	1-163-009-11	CERAMIC CHIP 0.001UF	10.00% 50V
C030	1-163-009-11	CERAMIC CHIP 0.001UF	10.00% 50V
C032	1-163-021-91	CERAMIC CHIP 0.01UF	10.00% 50V
C033	1-163-009-11	CERAMIC CHIP 0.001UF	10.00% 50V
C035	1-163-009-11	CERAMIC CHIP 0.001UF	10.00% 50V
C036	1-163-009-11	CERAMIC CHIP 0.001UF	10.00% 50V
C037	1-137-354-11	FILM 0.01UF	5.00% 100V
C038	1-163-037-11	CERAMIC CHIP 0.022UF	10.00% 50V
C039	1-164-505-11	CERAMIC CHIP 2.2UF	16V
C040	1-163-017-00	CERAMIC CHIP 0.0047UF	10.00% 50V
C042	1-163-213-00	CERAMIC CHIP 0.0022UF	5.00% 50V
C043	1-163-037-11	CERAMIC CHIP 0.022UF	10.00% 50V
C044	1-164-346-11	CERAMIC CHIP 1UF	16V
C045	1-164-489-11	CERAMIC CHIP 0.22UF	10.00% 16V
C046	1-163-037-11	CERAMIC CHIP 0.022UF	10.00% 50V
C047	1-126-935-11	ELECT 470UF	20.00% 16V
C053	1-164-004-11	CERAMIC CHIP 0.1UF	10.00% 25V
C055	1-216-295-91	SHORT 0	
C100	1-126-933-11	ELECT 100UF	20.00% 16V
C103	1-126-965-11	ELECT 22UF	20.00% 50V
C105	1-163-021-91	CERAMIC CHIP 0.01UF	10.00% 50V
C106	1-126-933-11	ELECT 100UF	20.00% 16V
C110	1-163-113-00	CERAMIC CHIP 68PF	5.00% 50V
C111	1-163-113-00	CERAMIC CHIP 68PF	5.00% 50V
C253	1-164-336-11	CERAMIC CHIP 0.33UF	25V
C403	1-163-009-11	CERAMIC CHIP 0.001UF	10.00% 50V
C408	1-164-348-11	CERAMIC CHIP 0.12UF	10.00% 25V
C409	1-126-964-11	ELECT 10UF	20.00% 50V
C410	1-163-021-91	CERAMIC CHIP 0.01UF	10.00% 50V
C415	1-164-346-11	CERAMIC CHIP 1UF	16V
C421	1-163-009-11	CERAMIC CHIP 0.001UF	10.00% 50V
C426	1-163-009-11	CERAMIC CHIP 0.001UF	10.00% 50V
C437	1-164-346-11	CERAMIC CHIP 1UF	16V
C438	1-164-346-11	CERAMIC CHIP 1UF	16V
C449	1-164-492-11	CERAMIC CHIP 0.15UF	10.00% 16V
C501	1-126-968-11	ELECT 100UF	20.00% 50V
C502	1-163-038-91	CERAMIC CHIP 0.1UF	25V
C503	1-126-968-11	ELECT 100UF	20.00% 50V
C504	1-106-220-00	MYLAR 0.1UF	10.00% 100V
C505	1-137-194-81	MYLAR 0.47UF	5.00% 50V
C506	1-163-021-91	CERAMIC CHIP 0.01UF	10.00% 50V
C508	1-163-035-00	CERAMIC CHIP 0.047UF	50V

The components identified by shading and marked  $\Delta$  are critical for safety. Replace only with the part number specified.

A

REF. NO.	PART.NO	DESCRIPTION	REMARK	REF. NO.	PART.NO	DESCRIPTION	REMARK
C509	1-107-364-11	MYLAR 0.01UF	10.00% 400V	C619	1-164-644-11	CERAMIC 330PF	10.00% 500V
C510	1-163-005-11	CERAMIC CHIP 470PF	10.00% 50V	C620	1-135-871-21	FILM 15000PF	3% 800V
C513	1-128-560-11	ELECT 22UF	20.00% 100V	C621	1-164-644-11	CERAMIC 330PF	10.00% 500V
C515	1-104-666-11	ELECT 220UF	20.00% 25V	C622	$\Delta$ 1-104-571-91	CERAMIC 0.0015UF	10.00% 2KV
C517	1-104-666-11	ELECT 220UF	20.00% 25V	C623	$\Delta$ 1-104-571-91	CERAMIC 0.0015UF	10.00% 2KV
C518	1-106-375-12	MYLAR 0.022UF	10.00% 250V	C624	1-126-935-11	ELECT 470UF	20.00% 16V
C519	1-163-275-11	CERAMIC CHIP 0.001UF	5.00% 50V	C625	$\Delta$ 1-117-703-11	CERAMIC 0.0047UF	99% 250V
C520	1-163-038-91	CERAMIC CHIP 0.1UF	25V	C626	1-126-967-11	ELECT 47UF	20.00% 50V
C522	1-130-495-00	MYLAR 0.1UF	5.00% 50V	C627	1-126-964-11	ELECT 10UF	20.00% 50V
C524	1-216-295-91	SHORT 0		C628	1-126-963-11	ELECT 4.7UF	20.00% 50V
C525	1-123-024-21	ELECT 33UF	160V	C630	1-107-640-41	ELECT 100UF	20.00% 160V
C531	1-126-964-11	ELECT 10UF	20.00% 50V	C631	1-126-942-61	ELECT 1000UF	20.00% 25V
C532	1-163-021-91	CERAMIC CHIP 0.01UF	10.00% 50V	C632	1-126-964-11	ELECT 10UF	20.00% 50V
C535	1-163-251-11	CERAMIC CHIP 100PF	5.00% 50V	C633	1-163-009-11	CERAMIC CHIP 0.001UF	10.00% 50V
C536	1-119-859-11	FILM 0.36UF	5.00% 250V	C635	1-136-165-00	MYLAR 0.1UF	5.00% 50V
C537	1-106-343-00	MYLAR 0.001UF	10.00% 200V	C636	1-136-479-11	FILM 0.001UF	2.00% 50V
C538	1-165-319-11	CERAMIC CHIP 0.1UF	50V	C637	1-126-967-11	ELECT 47UF	20.00% 50V
C539	1-107-642-91	ELECT 3.3UF	20.00% 200V	C638	1-107-679-91	ELECT 10UF	20.00% 450V
C540	1-136-206-11	MYLAR 0.033UF	10.00% 400V	C639	1-104-665-11	ELECT 100UF	20.00% 25V
C541	1-106-383-00	MYLAR 0.047UF	10.00% 200V	C640	1-104-664-11	ELECT 47UF	20.00% 25V
C542	1-162-116-51	CERAMIC 680PF	10.00% 2KV	C641	1-111-036-11	ELECT 470UF	20.00% 16V
C545	1-164-004-11	CERAMIC CHIP 0.1UF	10.00% 25V	C642	1-104-665-11	ELECT 100UF	20.00% 25V
C546	1-129-716-00	FILM 0.015UF	5.00% 400V	C643	1-164-644-11	CERAMIC 330PF	10.00% 500V
C547	1-117-671-21	FILM 1UF	5.00% 250V	C645	1-164-004-11	CERAMIC CHIP 0.1UF	10.00% 25V
C550	1-107-638-11	ELECT 33UF	20.00% 160V	C648	1-125-782-91	CERAMIC 4700PF	10.00% 1KV
C552	1-102-212-00	CERAMIC 820PF	10.00% 500V	C657	1-126-952-11	ELECT 1000UF	20.00% 35V
C555	1-117-637-31	FILM 5600PF	3.00% 1.2KV	C1201	1-126-952-11	ELECT 1000UF	20.00% 35V
C580	1-163-021-91	CERAMIC CHIP 0.01UF	10.00% 50V	C1203	1-126-942-61	ELECT 1000UF	20.00% 25V
C582	1-163-255-11	CERAMIC CHIP 150PF	5.00% 50V	C1205	1-163-033-91	CERAMIC CHIP 0.022UF	50V
C583	1-163-009-11	CERAMIC CHIP 0.001UF	10.00% 50V	C1207	1-115-340-11	CERAMIC CHIP 0.22UF	10.00% 25V
C600	$\Delta$ 1-119-888-51	CERAMIC 2200PF	20.00% 250V	C1208	1-535-303-00	LEAD, JUMPER (5.00MM)	
C601	$\Delta$ 1-136-516-12	FILM 0.1UF	20.00% 300V	C1218	1-109-982-11	CERAMIC CHIP 1UF	10.00% 10V
C602	$\Delta$ 1-136-516-12	FILM 0.1UF	20.00% 300V	C1219	1-104-666-11	ELECT 220UF	20.00% 25V
C603	$\Delta$ 1-119-888-51	CERAMIC 2200PF	20.00% 250V	C1220	1-164-346-11	CERAMIC CHIP 1UF	16V
C604	$\Delta$ 1-119-888-51	CERAMIC 2200PF	20.00% 250V	C1221	1-115-339-11	CERAMIC CHIP 0.1UF	10.00% 50V
C605	1-126-935-11	ELECT 470UF	20.00% 16V	C1223	1-163-125-00	CERAMIC CHIP 220PF	5.00% 50V
C606	1-125-991-11	ELECT 180UF	20% 450V	C1226	1-110-501-11	CERAMIC CHIP 0.33UF	10.00% 16V
C607	1-126-964-11	ELECT 10UF	20.00% 50V	C1227	1-163-125-00	CERAMIC CHIP 220PF	5.00% 50V
C608	1-126-963-11	ELECT 4.7UF	20.00% 50V				
C610	1-126-941-11	ELECT 470UF	20.00% 25V			< CONNECTOR >	
C611	1-163-009-11	CERAMIC CHIP 0.001UF	10.00% 50V	CN001	*1-564-508-11	PLUG, CONNECTOR 5P	
C612	$\Delta$ 1-104-571-91	CERAMIC 0.0015UF	10.00% 2KV	CN501	*1-580-798-11	CONNECTOR PIN (DY)	
C613	$\Delta$ 1-104-571-91	CERAMIC 0.0015UF	10.00% 2KV	CN504	*1-564-509-11	PLUG, CONNECTOR 6P	
C614	$\Delta$ 1-161-964-51	CERAMIC 0.0047UF	250V	CN508	*1-564-508-11	PLUG, CONNECTOR 5P	
C615	1-115-339-11	CERAMIC CHIP 0.1UF	10.00% 50V	CN601	$\Delta$ *1-580-843-11	PIN, CONNECTOR (POWER)	
C617	1-164-644-11	CERAMIC 330PF	10.00% 500V	CN602	$\Delta$ 1-508-765-00	PIN, CONNECTOR (5MM PITCH) 3P	
C618	1-126-949-11	ELECT 220UF	20.00% 35V	CN603	$\Delta$ *1-508-786-00	PIN, CONNECTOR (5MM PITCH) 2P	



The components identified by shading and marked  $\Delta$  are critical for safety  
 Replace only with the part number specified.

REF. NO.	PART.NO	DESCRIPTION	REMARK	REF. NO.	PART.NO	DESCRIPTION	REMARK
CN604	$\Delta$ 1-695-915-11	TAB (CONTACT)		D505	8-719-988-61	DIODE 1SS355TE-17	
CN1201	*1-564-506-11	PLUG, CONNECTOR 3P		D506	8-719-908-03	DIODE GP08DPKG23	
		< DIODE >		D507	8-719-070-56	DIODE PDZ5.1B-115	
D001	8-719-069-55	DIODE UDZS-TE17-5.6B		D512	8-719-908-03	DIODE GP08DPKG23	
D002	8-719-069-55	DIODE UDZS-TE17-5.6B		D513	8-719-950-57	DIODE BYD33G-AMMO	
D003	8-719-109-69	DIODE MTZJ-T-77-3.6B		D514	8-719-908-03	DIODE GP08DPKG23	
D004	8-719-302-45	DIODE SEL1210S-D		D534	8-719-908-03	DIODE GP08DPKG23	
D005	8-719-110-08	DIODE MTZJ-T-77-8.2B		D535	8-719-908-03	DIODE GP08DPKG23	
D006	8-719-109-89	DIODE MTZJ-T-77-5.6B		D536	8-719-945-80	DIODE ERC06-15SL	
D007	8-719-069-55	DIODE UDZS-TE17-5.6B		D537	8-719-110-14	DIODE MTZJ-T-77-9.1C	
D008	8-719-074-43	DIODE BAS316-115		D538	8-719-908-03	DIODE GP08DPKG23	
D010	8-719-074-43	DIODE BAS316-115		D539	8-719-928-08	DIODE ERD28-06S	
D011	8-719-074-43	DIODE BAS316-115		D541	1-535-303-00	LEAD, JUMPER (5.00MM)	
D012	8-719-110-08	DIODE MTZJ-T-77-8.2B		D573	8-719-976-96	DIODE UDZ-TE-17-4.7B	
D013	8-719-109-69	DIODE MTZJ-T-77-3.6B		D601	8-719-510-53	DIODE D4SB60L-F	
D014	8-719-422-12	DIODE UDZ-TE-17-3.9B		D602	8-719-911-19	DIODE 1SS119-25TD	
D016	8-719-109-89	DIODE MTZJ-T-77-5.6B		D604	8-719-979-64	DIODE UF4005PKG23	
D017	8-719-109-97	DIODE MTZJ-T-77-6.8B		D608	8-719-063-70	DIODE DINL20U-TA2	
D018	8-719-109-69	DIODE MTZJ-T-77-3.6B		D610	8-719-110-41	DIODE RD15ES-T1B2	
D019	8-719-109-97	DIODE MTZJ-T-77-6.8B		D611	8-719-991-33	DIODE 1SS133T-77	
D020	8-719-109-89	DIODE MTZJ-T-77-5.6B		D612	8-719-991-33	DIODE 1SS133T-77	
D035	8-719-069-55	DIODE UDZS-TE17-5.6B		<b>D613</b>	$\Delta$ 8-719-911-19	DIODE 1SS119-25TD	
D036	8-719-069-55	DIODE UDZS-TE17-5.6B		D614	8-719-077-76	DIODE D2SB60A-F04	
D051	8-719-069-57	DIODE UDZS-TE17-6.8B		D615	8-719-110-08	DIODE MTZJ-T-77-8.2B	
D101	8-719-977-81	DIODE MA8330-TX		D616	8-719-052-90	DIODE DINL40-TA2	
D103	8-719-069-57	DIODE UDZS-TE17-6.8B		D617	8-719-052-90	DIODE DINL40-TA2	
D104	8-719-069-55	DIODE UDZS-TE17-5.6B		D618	8-719-022-97	DIODE D2S4MTA1	
D210	8-719-069-55	DIODE UDZS-TE17-5.6B		D619	8-719-022-97	DIODE D2S4MTA1	
D211	8-719-069-60	DIODE UDZS-TE17-9.1B		D620	8-719-109-85	DIODE MTZJ-T-77-5.1B	
D212	8-719-914-43	DIODE DAN202K-T-146		D621	8-719-109-89	DIODE MTZJ-T-77-5.6B	
D402	8-719-069-57	DIODE UDZS-TE17-6.8B		D623	8-719-911-19	DIODE 1SS119-25TD	
D405	8-719-069-57	DIODE UDZS-TE17-6.8B		D627	8-719-063-70	DIODE DINL20-TA	
D406	8-719-069-57	DIODE UDZS-TE17-6.8B		D629	8-719-073-23	DIODE ST02D-200TA	
D407	8-719-069-57	DIODE UDZS-TE17-6.8B		D631	8-719-921-63	DIODE MTZJ-T-77-7.5B	
D412	8-719-069-57	DIODE UDZS-TE17-6.8B		D632	8-719-063-70	DIODE DINL20U-TA2	
D414	8-719-069-57	DIODE UDZS-TE17-6.8B		D633	8-719-109-69	DIODE MTZJ-T-77-3.6B	
D420	8-719-069-57	DIODE UDZS-TE17-6.8B		D634	8-719-074-43	DIODE BAS316-115	
D421	8-719-049-26	DIODE RB721QT-77		D639	8-719-080-59	DIODE EK19-V0	
D423	8-719-069-57	DIODE UDZS-TE17-6.8B		D640	8-719-921-63	DIODE MTZJ-T-77-7.5B	
D424	8-719-069-60	DIODE UDZS-TE17-9.1B		D1201	8-719-069-55	DIODE UDZS-TE17-5.6B	
D435	8-719-069-60	DIODE UDZS-TE17-9.1B		D1203	8-719-914-43	DIODE DAN202K-T-146	
D436	8-719-069-60	DIODE UDZS-TE17-9.1B		D1204	8-719-069-55	DIODE UDZS-TE17-5.6B	
D501	8-719-908-03	DIODE GP08DPKG23				< FUSE >	
D502	8-719-056-95	DIODE UDZ-TE-17-22B		<b>F601</b>	$\Delta$ 1-576-232-21	FUSE (H.B.C.) 5A/250V	
D503	8-719-069-55	DIODE UDZS-TE17-5.6B			$\Delta$ *1-533-725-11	HOLDER, FUSE (F601)	
D504	8-719-074-43	DIODE BAS316-115					



The components identified by shading and marked  $\Delta$  are critical for safety  
 Replace only with the part number specified.

A

REF. NO.	PART.NO	DESCRIPTION	REMARK	REF. NO.	PART.NO	DESCRIPTION	REMARK
< FERRITE BEAD >				L601	1-408-603-31	INDUCTOR	10UH
FB601	1-410-397-21	FERRITE	1.1UH	L602	1-408-611-31	INDUCTOR	47UH
FB604	1-410-397-21	FERRITE	1.1UH	L603	1-412-524-11	INDUCTOR	8.2UH
FB605	1-410-397-21	FERRITE	1.1UH	L1200	1-535-303-00	LEAD, JUMPER	(5.0MM)
FB606	$\Delta$ 1-412-911-11	FERRITE	0UH	L1203	1-535-303-00	LEAD, JUMPER	(5.0MM)
FB607	$\Delta$ 1-412-911-11	FERRITE	0UH	< PHOTO COUPLER >			
< IC >				PH601	$\Delta$ 8-749-016-21	IC TCET1103G	
IC002	8-749-017-44	IC TSOP1540SE1		< TRANSISTOR >			
IC003	8-759-672-39	IC PST5731MT		Q016	8-729-120-28	TRANSISTOR	2SC2412K-T-146-R
IC501	8-759-324-56	IC TDA9302H		Q212	8-729-422-33	TRANSISTOR	2PD601AR-115
IC531	8-759-665-11	IC LM393DT		Q401	8-729-026-49	TRANSISTOR	2SA1037AK-T146-QR
IC601	8-759-671-30	IC MCZ3001D		Q411	8-729-120-28	TRANSISTOR	2SC2412K-T-146-R
IC602	8-749-016-19	IC SE135N-LF4		Q532	8-729-053-33	TRANSISTOR	IRF614-037
IC604	8-759-668-87	IC BA41W12ST-V5		Q533	8-729-051-82	TRANSISTOR	BU4508DX-ON5210
IC608	8-759-591-02	IC L78L33ABZ-AP		Q535	8-729-053-33	TRANSISTOR	IRF614-037
IC609	8-759-468-89	IC TOP209P		Q601	8-729-026-49	TRANSISTOR	2SA1037AK-T146-QR
IC1201	8-759-665-29	IC TDA7494S		Q602	8-729-119-78	TRANSISTOR	2SC1740S-RT
< SOCKET >				Q603	8-729-029-56	TRANSISTOR	DTA144ESA-TP
J401	1-770-130-11	CONNECTOR (SQUARE TYPE) 21P		Q604	8-729-030-02	TRANSISTOR	DTC144ESA-TP
J402	1-794-344-11	JACK, PIN 2P		Q606	8-729-052-29	TRANSISTOR	2SK2876-01MR-F122
J1200	1-568-267-21	JACK		Q607	8-729-052-29	TRANSISTOR	2SK2876-01MR-F122
< COIL >				Q608	8-729-120-28	TRANSISTOR	2SC2412K-T-146-QR
L001	1-408-611-31	INDUCTOR	47UH	Q609	8-729-026-49	TRANSISTOR	2SA1037AK-T146-QR
L002	1-410-119-11	INDUCTOR	1MH	< RESISTOR >			
L004	1-408-611-31	INDUCTOR	47UH	JR002	1-216-295-91	SHORT	0
L006	1-408-611-31	INDUCTOR	47UH	JR009	1-216-295-91	SHORT	0
L027	1-216-295-91	SHORT	0	JR023	1-216-295-91	SHORT	0
L101	1-412-533-21	INDUCTOR	47UH	JR208	1-216-295-91	SHORT	0
L102	1-408-611-31	INDUCTOR	47UH	JR401	1-216-295-91	SHORT	0
L405	1-535-303-00	LEAD, JUMPER	(5.0MM)	JR404	1-216-295-91	SHORT	0
L407	1-535-303-00	LEAD, JUMPER	(5.0MM)	JR408	1-216-296-91	SHORT	0
L410	1-216-025-91	RES-CHIP	100 5% 1/10W	JR409	1-216-295-91	SHORT	0
L446	1-216-295-91	SHORT	0	JR420	1-216-295-91	SHORT	0
L501	1-414-187-11	INDUCTOR	47UH	JR508	1-216-295-91	SHORT	0
L502	1-412-531-31	INDUCTOR	33UH	JR516	1-216-296-91	SHORT	0
L503	1-412-521-31	INDUCTOR	4.7UH	JR517	1-216-296-91	SHORT	0
L504	1-535-303-00	LEAD, JUMPER	(5.0MM)	JR601	1-216-296-91	SHORT	0
L505	1-535-303-00	LEAD, JUMPER	(5.0MM)	JR609	1-216-296-91	SHORT	0
L507	1-412-533-21	INDUCTOR	47UH	R003	1-216-065-91	RES-CHIP	4.7K 5% 1/10W
L532	1-412-553-11	INDUCTOR	3.3MH	R004	1-216-033-00	RES-CHIP	220 5% 1/10W
L533	1-406-989-21	INDUCTOR	10MH	R005	1-216-190-00	RES-CHIP	470 5% 1/8W
L535	1-459-111-00	INDUCTOR	10MH	R006	1-216-025-91	RES-CHIP	100 5% 1/10W
L537	1-419-551-11	COIL, HORIZONTAL LINEARITY		R007	1-216-025-91	RES-CHIP	100 5% 1/10W
L538	1-406-984-11	INDUCTOR	1.5MH	R008	1-216-025-91	RES-CHIP	100 5% 1/10W



REF. NO.	PART. NO	DESCRIPTION	REMARK			REF. NO.	PART. NO	DESCRIPTION	REMARK		
R009	1-216-049-91	RES-CHIP	1K	5%	1/10W	R070	1-216-025-91	RES-CHIP	100	5%	1/10W
R010	1-216-049-91	RES-CHIP	1K	5%	1/10W	R071	1-216-049-91	RES-CHIP	1K	5%	1/10W
R011	1-216-295-91	SHORT	0			R072	1-216-295-91	SHORT	0		
R012	1-216-113-00	RES-CHIP	470K	5%	1/10W	R074	1-216-073-00	RES-CHIP	10K	5%	1/10W
R014	1-216-069-00	RES-CHIP	6.8K	5%	1/10W	R075	1-216-295-91	SHORT	0		
R017	1-216-174-00	RES-CHIP	100	5%	1/8W	R089	1-216-295-91	SHORT	0		
R018	1-216-689-11	METAL CHIP	39K	0.5%	1/10W	R093	1-216-081-00	RES-CHIP	22K	5%	1/10W
R020	1-216-077-91	RES-CHIP	15K	5%	1/10W	R094	1-216-025-91	RES-CHIP	100	5%	1/10W
R021	1-216-065-91	RES-CHIP	4.7K	5%	1/10W	R095	1-216-065-91	RES-CHIP	4.7K	5%	1/10W
R022	1-216-089-91	RES-CHIP	47K	5%	1/10W	R096	1-216-025-91	RES-CHIP	100	5%	1/10W
R023	1-216-180-00	RES-CHIP	180	5%	1/8W	R101	1-216-093-91	RES-CHIP	68K	5%	1/10W
R024	1-216-025-91	RES-CHIP	100	5%	1/10W	R102	1-216-097-91	RES-CHIP	100K	5%	1/10W
R025	1-216-025-91	RES-CHIP	100	5%	1/10W	R104	1-216-295-91	SHORT	0		
R026	1-216-025-91	RES-CHIP	100	5%	1/10W	R106	1-215-900-11	METAL OXIDE	22K	5%	2W
R027	1-216-025-91	RES-CHIP	100	5%	1/10W	R107	1-216-025-91	RES-CHIP	100	5%	1/10W
R028	1-216-025-91	RES-CHIP	100	5%	1/10W	R108	1-216-025-91	RES-CHIP	100	5%	1/10W
R029	1-216-061-00	RES-CHIP	3.3K	5%	1/10W	R246	1-260-107-11	CARBON	4.7K	5%	1/2W
R031	1-216-210-00	RES-CHIP	3.3K	5%	1/8W	R248	1-249-429-11	CARBON	10K	5%	1/4W
R033	1-216-073-00	RES-CHIP	10K	5%	1/10W	R249	1-216-097-91	RES-CHIP	100K	5%	1/10W
R034	1-216-123-11	RES-CHIP	1.2M	5%	1/10W	R250	1-216-230-00	RES-CHIP	22K	5%	1/8W
R035	1-216-101-00	RES-CHIP	150K	5%	1/10W	R401	1-216-214-00	RES-CHIP	4.7K	5%	1/8W
R036	1-216-083-00	RES-CHIP	27K	5%	1/10W	R404	1-216-113-00	RES-CHIP	470K	5%	1/10W
R038	1-216-295-91	SHORT	0			R406	1-216-214-00	RES-CHIP	4.7K	5%	1/8W
R039	1-216-214-00	RES-CHIP	4.7K	5%	1/8W	R408	1-216-022-00	RES-CHIP	75	5%	1/10W
R040	1-216-049-91	RES-CHIP	1K	5%	1/10W	R409	1-216-025-91	RES-CHIP	100	5%	1/10W
R041	1-216-025-91	RES-CHIP	100	5%	1/10W	R410	1-216-025-91	RES-CHIP	100	5%	1/10W
R042	1-216-025-91	RES-CHIP	100	5%	1/10W	R411	1-216-022-00	RES-CHIP	75	5%	1/10W
R044	1-216-073-00	RES-CHIP	10K	5%	1/10W	R412	1-216-025-91	RES-CHIP	100	5%	1/10W
R045	1-216-025-91	RES-CHIP	100	5%	1/10W	R414	1-216-022-00	RES-CHIP	75	5%	1/10W
R046	1-216-025-91	RES-CHIP	100	5%	1/10W	R415	1-216-022-00	RES-CHIP	75	5%	1/10W
R047	1-216-025-91	RES-CHIP	100	5%	1/10W	R416	1-216-027-00	RES-CHIP	120	5%	1/10W
R048	1-216-073-00	RES-CHIP	10K	5%	1/10W	R419	1-216-022-00	RES-CHIP	75	5%	1/10W
R050	1-216-174-00	RES-CHIP	100	5%	1/8W	R421	1-216-049-91	RES-CHIP	1K	5%	1/10W
R051	1-216-295-91	SHORT	0			R423	1-216-113-00	RES-CHIP	470K	5%	1/10W
R055	1-216-174-00	RES-CHIP	100	5%	1/8W	R425	1-216-085-00	RES-CHIP	33K	5%	1/10W
R056	1-216-025-91	RES-CHIP	100	5%	1/10W	R426	1-216-073-00	RES-CHIP	10K	5%	1/10W
R057	1-216-083-00	RES-CHIP	27K	5%	1/10W	R435	1-216-295-91	SHORT	0		
R060	1-216-174-00	RES-CHIP	100	5%	1/8W	R440	1-216-049-91	RES-CHIP	1K	5%	1/10W
R061	1-216-174-00	RES-CHIP	100	5%	1/8W	R441	1-216-051-00	RES-CHIP	1.2K	5%	1/10W
R062	1-216-077-91	RES-CHIP	15K	5%	1/10W	R444	1-216-061-00	RES-CHIP	3.3K	5%	1/10W
R063	1-216-061-00	RES-CHIP	3.3K	5%	1/10W	R445	1-216-022-00	RES-CHIP	75	5%	1/10W
R064	1-216-069-00	RES-CHIP	6.8K	5%	1/10W	R446	1-216-113-00	RES-CHIP	470K	5%	1/10W
R065	1-216-295-91	SHORT	0			R447	1-216-295-91	SHORT	0		
R066	1-216-053-00	RES-CHIP	1.5K	5%	1/10W	R453	1-216-171-00	RES-CHIP	75	5%	1/8W
R067	1-216-073-00	RES-CHIP	10K	5%	1/10W	R454	1-216-001-00	RES-CHIP	10	5%	1/10W
R068	1-216-083-00	RES-CHIP	27K	5%	1/10W	R461	1-216-022-00	RES-CHIP	75	5%	1/10W
R069	1-216-073-00	RES-CHIP	10K	5%	1/10W	R501	1-216-091-00	RES-CHIP	56K	5%	1/10W

The components identified by shading and marked  $\Delta$  are critical for safety  
 Replace only with the part number specified.

A

REF. NO.	PART.NO	DESCRIPTION	REMARK	REF. NO.	PART.NO	DESCRIPTION	REMARK
R502	1-216-073-00	RES-CHIP	10K 5% 1/10W	R561	1-216-129-00	RES-CHIP	2.2M 5% 1/10W
R503	1-215-888-00	METAL OXIDE	220 5% 2W	R562	1-216-121-91	RES-CHIP	1M 5% 1/10W
R504	1-249-385-11	CARBON	2.2 5% 1/4W	R565	1-216-025-91	RES-CHIP	100 5% 1/10W
R505	1-216-677-11	METAL CHIP	12K 0.5% 1/10W	R583	1-216-081-00	RES-CHIP	22K 5% 1/10W
R506	1-216-665-11	METAL CHIP	3.9K 0.5% 1/10W	R589	1-216-295-91	SHORT	0
R507	1-216-349-00	METAL OXIDE	1 5% 1W	R591	1-217-778-11	FUSIBLE	1K 5% 1W
R508	1-216-677-11	METAL CHIP	12K 0.5% 1/10W	R595	1-249-377-11	CARBON	0.47 5% 1/4W
R509	1-216-665-11	METAL CHIP	3.9K 0.5% 1/10W	R600	1-216-619-11	METAL CHIP	47 0.5% 1/10W
R510	1-216-113-00	RES-CHIP	470K 5% 1/10W	R601	1-216-641-11	METAL CHIP	390 0.5% 1/10W
R512	1-249-382-11	CARBON	1.2 5% 1/4W	R602	1-202-962-11	CEMENTED	3.3 5% 10W
R513	1-216-097-91	RES-CHIP	100K 5% 1/10W	R603	1-220-926-11	FUSIBLE	0.47 10% 1/2W
R514	1-249-377-11	CARBON	0.47 5% 1/4W	R605	1-216-049-91	RES-CHIP	1K 5% 1/10W
R515	1-249-377-11	CARBON	0.47 5% 1/4W	R606	$\Delta$ 1-202-719-00	SOLID	1M 10% 1/2W
R516	1-214-907-00	METAL	56K 1% 1/2W	R608	1-216-073-00	RES-CHIP	10K 5% 1/10W
R517	1-215-469-00	METAL	100K 1% 1/4W	R609	1-216-675-91	METAL CHIP	10K 0.5% 1/10W
R518	1-216-663-11	METAL CHIP	3.3K 0.5% 1/10W	R610	1-215-481-00	METAL	330K 1% 1/4W
R520	1-215-883-11	METAL OXIDE	33 5% 2W	R611	1-216-059-00	RES-CHIP	2.7K 5% 1/10W
R521	1-216-109-00	RES-CHIP	330K 5% 1/10W	R612	1-249-429-11	CARBON	10K 5% 1/4W
R522	1-216-069-00	RES-CHIP	6.8K 5% 1/10W	R613	$\Delta$ 1-218-265-11	METAL	8.2M 5% 1W
R523	1-216-117-00	RES-CHIP	680K 5% 1/10W	R615	1-215-405-00	METAL	220 1% 1/4W
R524	1-216-075-00	RES-CHIP	12K 5% 1/10W	R618	1-247-889-00	CARBON	270K 5% 1/4W
R525	1-216-057-00	RES-CHIP	2.2K 5% 1/10W	R619	1-216-065-91	RES-CHIP	4.7K 5% 1/10W
R526	1-216-089-91	RES-CHIP	47K 5% 1/10W	R621	1-216-113-00	RES-CHIP	470K 5% 1/10W
R527	1-216-075-00	RES-CHIP	12K 5% 1/10W	R622	1-216-073-00	RES-CHIP	10K 5% 1/10W
R528	1-216-097-91	RES-CHIP	100K 5% 1/10W	R623	1-216-081-00	RES-CHIP	22K 5% 1/10W
R529	1-216-073-00	RES-CHIP	10K 5% 1/10W	R624	1-216-001-00	RES-CHIP	10 5% 1/10W
R530	1-216-085-00	RES-CHIP	33K 5% 1/10W	R625	1-216-073-00	RES-CHIP	10K 5% 1/10W
R531	1-216-057-00	RES-CHIP	2.2K 5% 1/10W	R627	1-249-389-11	CARBON	4.7 5% 1/4W
R532	1-216-059-00	RES-CHIP	2.7K 5% 1/10W	R628	1-247-791-91	CARBON	22 5% 1/4W
R533	1-216-081-00	RES-CHIP	22K 5% 1/10W	R629	1-216-073-00	RES-CHIP	10K 5% 1/10W
R534	1-216-093-91	RES-CHIP	68K 5% 1/10W	R632	1-249-417-11	CARBON	1K 5% 1/4W
R535	1-216-083-00	RES-CHIP	27K 5% 1/10W	R633	1-215-481-00	METAL	330K 1% 1/4W
R539	1-215-892-11	METAL OXIDE	1K 5% 2W	R634	1-216-341-11	METAL OXIDE	0.22 5% 1W
R540	1-217-495-00	FUSIBLE	150 5% 1W	R635	1-260-300-11	CARBON	4.7 5% 1/2W
R542	1-216-121-91	RES-CHIP	1M 5% 1/10W	R636	1-249-413-11	CARBON	470 5% 1/4W
R543	1-216-065-91	RES-CHIP	4.7K 5% 1/10W	R637	1-216-041-00	RES-CHIP	470 5% 1/10W
R544	1-216-103-00	RES-CHIP	180K 5% 1/10W	R639	1-216-683-11	METAL CHIP	22K 0.5% 1/10W
R546	1-215-923-00	METAL OXIDE	10K 5% 3W	R640	1-216-699-91	METAL CHIP	100K 0.5% 1/10W
R547	1-535-143-71	LEAD, JUMPER (7.5MM)		R641	1-216-097-91	RES-CHIP	100K 5% 1/10W
R548	1-212-849-00	FUSIBLE	4.7 5% 1/4W	R642	1-249-405-11	CARBON	100 5% 1/4W
R549	1-216-362-11	METAL OXIDE	0.27 5% 2W	R643	1-216-089-91	RES-CHIP	47K 5% 1/10W
R551	1-215-873-00	METAL OXIDE	4.7K 5% 1W	R645	1-216-073-00	RES-CHIP	10K 5% 1/10W
R552	1-216-097-91	RES-CHIP	100K 5% 1/10W	R647	1-216-049-91	RES-CHIP	1K 5% 1/10W
R553	1-249-381-11	CARBON	1 5% 1/4W	R648	1-215-481-00	METAL	330K 1% 1/4W
R557	1-216-065-91	RES-CHIP	4.7K 5% 1/10W	R649	1-216-674-11	METAL CHIP	9.1K 0.5% 1/10W
R558	1-216-025-91	RES-CHIP	100 5% 1/10W	R650	1-216-627-11	METAL CHIP	100 0.5% 1/10W
R559	1-247-863-91	CARBON	22K 5% 1/4W	R651	$\Delta$ 1-220-926-11	FUSIBLE	0.47 10% 1/2W

**A**

The components identified by shading and marked **△** are critical for safety  
 Replace only with the part number specified.

REF. NO.	PART.NO	DESCRIPTION	REMARK
R652	1-216-081-00	RES-CHIP 22K 5% 1/10W	
R653	1-216-073-00	RES-CHIP 10K 5% 1/10W	
R654	1-216-001-00	RES-CHIP 10 5% 1/10W	
R656	1-216-365-00	METAL OXIDE 0.47 5% 2W	
R660	1-247-807-31	CARBON 100 5% 1/4W	
R1200	1-260-093-81	CARBON 330 5% 1/2W	
R1201	1-260-093-81	CARBON 330 5% 1/2W	
R1204	1-216-049-91	RES-CHIP 1K 5% 1/10W	
R1205	1-216-061-00	RES-CHIP 3.3K 5% 1/10W	
R1206	1-216-073-00	RES-CHIP 10K 5% 1/10W	
R1207	1-216-083-00	RES-CHIP 27K 5% 1/10W	
R1213	1-216-198-91	RES-CHIP 1K 5% 1/8W	
< RELAY >			
RY601	△ 1-755-388-11	RELAY (AC POWER)	
< SWITCH >			
S001	1-571-532-21	SWITCH, TACTIL	
S002	1-571-532-21	SWITCH, TACTIL	
S003	1-571-532-21	SWITCH, TACTIL	
S004	1-571-532-21	SWITCH, TACTIL	
S005	1-571-532-21	SWITCH, TACTIL	
S006	1-571-532-21	SWITCH, TACTIL	
S601	△ 1-571-433-21	SWITCH, PUSH (AC POWER)	
SW532	1-572-707-11	SWITCH, LEVER	
< TRANSFORMER >			
T511	△ 1-453-347-11	TRANSFORMER ASSY, FLYBACK (NX-1747//U2A4)	
T531	1-437-210-11	TRANSFORMER, HORIZONTAL DRIVE	
T601	△ 1-435-487-11	TRANSFORMER, LINE FILTER	
T602	1-431-732-11	TRANSFORMER, CONVERTER (SRT)	
T603	△ 1-435-525-11	TRANSFORMER, CONVERTER (PIT)	
< THERMISTOR >			
TH601	1-803-586-11	THERMISTOR, NTC	
THP601	△ 1-803-951-11	THERMISTOR, PTC	
< VARISTOR >			
VDR601	△ 1-803-830-11	VARISTOR (ERZV14D621)	
< CRYSTAL >			
X001	1-578-774-11	VIBRATOR, CRYSTAL+	

REF. NO.	PART.NO	DESCRIPTION	REMARK
<b>A Board Variant Parts KV-14LM1</b>			
< IC >			
IC001	8-759-671-89	IC TDA9390H/N1/3/0130/T3	
IC004	8-759-575-71	IC M24C04-WMN6T	
< TUNER >			
TU101	8-598-535-00	FRONTEND BTF-EF411 (KV-14LM1B)	
	8-598-531-00	FRONTEND BTF-EF401 (KV-14LM1E)	
	8-598-537-00	FRONTEND BTF-EP401 (KV-14LM1K)	
	8-598-527-00	FRONTEND BTF-EU601 (KV-14LM1U)	
<b>A Board Variant Parts KV-14LT1</b>			
< CAPACITOR >			
C416	1-126-964-11	ELECT 10UF 20.00% 50V	
< DIODE >			
D404	8-719-923-38	DIODE MTZJ-T-77-5.6B	
D408	8-719-069-57	DIODE UDZS-TE17-6.8B	
< IC >			
IC001	8-759-671-88	IC TDA9329H/N1/4/0131/T3	
IC004	8-759-575-72	IC M24C08-WMN6T	
IC401	8-759-665-11	IC LM393DT	
< RESISTOR >			
JR406	1-216-295-91	SHORT 0	
R420	1-216-073-00	RES-CHIP 10K 5% 1/10W	
R428	1-216-073-00	RES-CHIP 10K 5% 1/10W	
R429	1-216-089-91	RES-CHIP 47K 5% 1/10W	
	1-216-073-00	RES-CHIP 10K 5% 1/10W	(KV-14LT1B)
			(KV-14LT1E/14LT1K/14LT1U)
R430	1-216-073-00	RES-CHIP 10K 5% 1/10W	
R431	1-216-073-00	RES-CHIP 10K 5% 1/10W	
R433	1-216-073-00	RES-CHIP 10K 5% 1/10W	
R434	1-216-073-00	RES-CHIP 10K 5% 1/10W	
< TUNER >			
TU101	8-598-535-00	FRONTEND BTF-EF411 (KV-14LT1B)	
	8-598-531-00	FRONTEND BTF-EF401 (KV-14LT1E)	
	8-598-537-00	FRONTEND BTF-EP401 (KV-14LT1K)	
	8-598-527-00	FRONTEND BTF-EU601 (KV-14LT1U)	

The components identified by shading and marked  $\Delta$  are critical for safety  
 Replace only with the part number specified.

**A**

REF. NO.	PART.NO	DESCRIPTION	REMARK	REF. NO.	PART.NO	DESCRIPTION	REMARK
----------	---------	-------------	--------	----------	---------	-------------	--------

**MISCELLANEOUS**

$\Delta$	1-419-548-11	COIL DEGAUSSING	
	1-452-032-00	MAGNET, DISK; 10MM	
	1-452-094-00	MAGNET, ROTATABLE DISK; 15MM	
$\Delta$	1-453-347-11	TRANSFORMER ASSY, FLYBACK (NX-1747//U2A4)	
	1-529-711-11	SPEAKER (8CM)	

$\Delta$	1-571-433-21	SWITCH, PUSH (AC POWER)	
$\Delta$	1-765-286-11	CORD, POWER (KV-14LM1B/14LM1E/14LM1K/ KV-14LT1B/14LT1E/14LT1K)	
$\Delta$	1-776-860-11	POWER CORD, FILTER (KV-14LM1B/14LT1B/ KV-14LM1U/14LT1U)	

	8-598-535-00	FRONTEND BTF-EF411 (KV-14LM1B/14LT1B)	
	8-598-531-00	FRONTEND BTF-EC401 (KV-14LM1E/14LT1E)	
	8-598-537-00	FRONTEND BTF-EP401 (KV-14LM1K/14LT1K)	
	8-598-527-00	FRONTEND BTF-EU601 (KV-14LM1U/14LT1U)	

$\Delta$	8-735-570-05	PICTURE TUBE (A34LRG70X)	
----------	--------------	--------------------------	--

$\Delta$	8-451-401-21	DEFLECTION YOKE (Y14RSA-L)	
$\Delta$	1-540-007-13	CAP ASSY, HIGH VOLTAGE	

**ACCESSORIES AND PACKAGING MATERIALS**

*4-205-481-21	MANUAL, INSTRUCTION (KV-14LM1B/14LT1B) (GERMAN/FRENCH/ENGLISH/ITALIAN/DUTCH)	
*4-205-481-51	MANUAL, INSTRUCTION (KV-14LM1E/14LT1E) (DANISH/GERMAN/SPANISH/GREEK/ITALIAN/ NORWEGIAN/PORTUGUESE/SWEDISH/FINNISH/TURKISH)	

*4-205-481-41	MANUAL, INSTRUCTION (KV-14LM1K/14LT1K) (BULGARIAN/CZECH/ENGLISH/DUTCH/ POLISH/RUSSIAN/SLOVAKIAN)	
*4-205-481-31	MANUAL, INSTRUCTION (KV-14LM1U/14LT1U) (ENGLISH)	

1-501-615-31	ANTENNA, LOOP (KV-14LM1)	
1-501-840-11	ANTENNA, TELESCOPIC (KV-14LT1)	
*4-039-905-11	BAG, PROTECTION	
*4-205-480-01	INDIVIDUAL CARTON	
*4-205-479-01	CUSHION (UPPER) (ASSY)	
*4-205-474-01	CUSHION (LOWER) (ASSY)	

**REMOTE COMMANDER**

1-418-476-21	REMOTE COMMANDER (RM-887) (14LT1)	
1-476-176-11	REMOTE COMMANDER (RM-889) (14LM1)	

# TRACE

A new TV Repair Assistance Tool that combines ease of use and powerful PC software tools to allow you to save valuable time during many TV repairs.



The TRACE interface connects to the PC's serial port. It provides connection to the TV's I<sup>2</sup>C bus and can be provided with an InfraRed transmitter (optional).

The interface is powered by a standard 9 V PP3 battery for portable use, and can also be powered by an external 9V/25mA DC power supply.

The TRACE software that is supplied with the interface allows you to:

- Read, restore and compare NVM contents via the I<sup>2</sup>C bus
- Acknowledge check of all I<sup>2</sup>C devices in the TV set
- Read Error Codes (emulation of the Error Reader tool)

With the optional IR Add-on kit, the following features can be added:

- Remote Commander emulation
- User programmable Functional Check through Infrared
- Fast and documented Test Mode setting of all Sony TV chassis

Additional features such as Adjustments and Troubleshooting are available in chassis-dependent software modules. Please contact your local Sony Service organisation for the latest information.

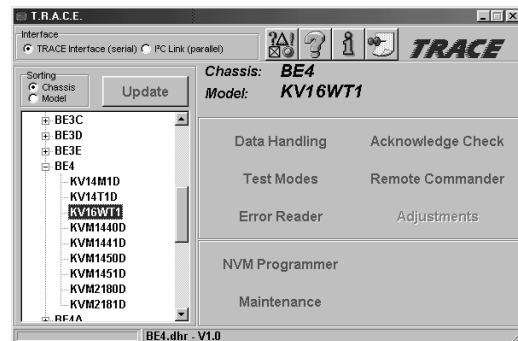

*Note: For workshops already using the existing I<sup>2</sup>C Link parallel port interface (9-948-320-30), this software can be used as well, replacing the TV Data Handling software (9-948-340-50), but Error Reader and IR functions can only be accessed with the TRACE interface.*

Partnumbers: TRACE Starter Kit (TRACE interface + software): 9-948-320-70  
TRACE Software (for users of the I<sup>2</sup>C Link interface): 9-948-340-80  
TRACE IR Add-on (IR interface + Remote Commander software): 9-948-320-80

PC requirements: IBM-compatible PC with operating system Windows95, Windows98, or WindowsNT\*.

\* WindowsNT only supported with TRACE interface